



BRIGHAM AND WOMEN'S HOSPITAL
Department of Rehabilitation Services

Physical Therapy

Standard of Care: Physical Therapy Management of the Patient with a Mechanical Circulatory Support Device

ICD 10 Codes¹:

I 20- I 25 Ischemic Heart Disease
I 40 – I 41 Acute Myocarditis
I 42- I 43 Cardiomyopathy
I 46 Cardiac Arrest
I 50 Heart Failure

Case Type / Diagnosis:

This standard of care applies to patients who have undergone placement of a mechanical circulatory support device (MCS), including ventricular assist devices (VAD) or total artificial heart (TAH) for end-stage heart disease. End stage heart disease is a growing problem in America and advanced disease has a mortality rate of one in five persons in the first year. Seventy-five percent of people with symptomatic heart failure have moderate to severe diastolic dysfunction and one in four death certificates list heart failure as the reason of death.^{2,3} There were over 1 million hospital discharges related to heart failure in 2013 and the estimated cost of heart failure in 2013 was 39.2 billion dollars in the US.^{2,3} Despite advances in medical management, heart transplantation remained the only option for many patients. Due to long waiting lists for organs, the National Heart, Lung and Blood Institute urged the development of cardiac mechanical assist devices in the 1970's. Since then, many devices have been developed and can be used for short or long term support.⁴

Ventricular assistive devices are used for refractory heart failure or cardiogenic shock, both of which can result from acute or chronic health conditions, including acute myocardial infarction, myocarditis, or progressive end stage heart failure. A VAD can be used to support the left ventricle (LVAD), the right ventricle (RVAD) or both ventricles (BiVAD). In 2013, there were 2,365 LVADs implanted, compared to the 247 implanted in 2007.⁵

Devices can be described in many ways including location of the pump or the mechanism of pumping. Pumping chambers can be located inside the body (called intracorporeal devices) or outside the body (called extracorporeal or paracorporeal devices). Furthermore, devices can be pulsatile or non-pulsatile. A pulsatile pumping mechanism has a sac and diaphragm which create a compressible blood chamber. The chamber expands to fill when blood enters it, and is emptied when compression of the diaphragm is triggered. This type

Standard of Care: Physical Therapy Management of the Patient with a Mechanical Circulatory Support Device

of device has valves which control blood flow to maintain forward flow of blood. Pulsatile VADs can be controlled by an electric motor or a pneumatic hand pump, in the case of VAD electrical malfunction. Non-pulsatile VADs are divided into axial flow pumps in which a propeller propels blood unidirectionally, and centrifugal pumps in which blood comes into the center of the pump, and is spun and accelerated out to the periphery of the plate.⁶ For all devices, the inflow cannulae bring blood from the peripheral circulation of the body to the VAD. Inflow cannulae remove blood from the atria or ventricle and decrease preload. The outflow cannulae bring blood from the VAD back to the body. In the case of the RVAD, the blood returns to the body via the pulmonary artery. In the case of an LVAD, the blood returns to the body via the aorta and provides or supplements cardiac output.⁶ With BiVAD support, both ventricles are supported.

The TAH is a pulsatile, biventricular pneumatically driven orthotopic device that is used as a bridge to cardiac transplant in patients who are at risk of imminent death⁷ due to biventricular failure. Biventricular failure can occur due to cardiogenic shock as a result of acute myocardial infarction, advanced heart failure including ischemic and non-ischemic cardiomyopathy along with transplant rejection and VAD failure.

With the TAH, both native ventricles and all four native heart valves are replaced by artificial ventricles and tilting disc valves, respectively.⁸ The artificial ventricles have inner diaphragms that are surrounded by a more supportive, rigid casing. Blood enters the artificial right ventricle from the native right atrium and partially fills before fully ejecting through a short outflow cannula grafted to the pulmonary artery. Blood returns from the lungs into the left atrium, flows into the artificial left ventricle, and when it is partially filled, is fully ejected into an outflow cannula grafted to the aorta to provide systemic circulation. The pneumatic driver delivers pulses through the drive lines into the air chambers of the ventricles to distend the diaphragms and trigger ejection of the blood. In each cycle, ventricles have the capacity to fill up to 70 mL with output of up to 9.5L/min.⁹

The indication for which design and brand of MCS is placed is patient or surgeon specific. In general, short term devices are placed for patients who are likely to have a rapid recovery, termed “bridge to recovery” or to stabilize them for another intervention to increase heart function, termed “bridge to decision”. These devices are used for a few days to a few months. Long term devices can be used for several months to years. These devices are often used as a “bridge to cardiac transplantation” if it is determined that the patient is a good candidate, or as an alternative to cardiac transplantation as end of life care, called “destination therapy.”⁶ Brigham and Women’s Hospital currently uses VADs made by Thoratec Corporation (PVAD[®], IVAD[®], Heartmate I[®], Heartmate II[®], Centrimag[®]), CardiacAssist, Inc. (TandemHeart[®]), HeartWare[®] (HVAD[®]) and SynCardia (TAH-t Temporary Total Artificial Heart). For specific information about each device, please see appendixes A through F.

Standard of Care:

Physical Therapy Management of the Patient with a Mechanical Circulatory Support Device

Indications for Treatment¹⁰:

The following structural and functional changes may be present after VAD placement

1. Body Structures
 - a. Heart (s4100)
 - b. Arteries (s4101)
 - c. Veins (s4102)
 - d. Capillaries (s4103)
 - e. Trachea (s4300)
 - f. Lungs (s4301)
 - g. Thoracic Cage (s4302)
 - h. Muscles of Respiration (s4303)
 - i. Skin Of Trunk And Back (s8105)
 - j. Skin of Upper Extremity (s8102)
 - k. Skin Of Lower Extremity (s8104)
2. Body Functions
 - a. Heart Functions (b410)
 - b. Blood Vessel Functions (b415)
 - c. Blood Pressure Functions (b420)
 - d. Respiratory Functions (b440)
 - e. Respiratory Muscle Functions (b445)
 - f. Additional Respiratory Functions (b449)
 - g. Exercise Tolerance (b455)
 - h. Energy and drive functions (b130)
 - i. Immunological system functions (b435)
 - j. Ingestion functions (b510)
 - k. Urinary excretory functions (b610)
 - l. Mobility of joint functions (b710)
 - m. Muscle power functions (b730)
 - n. Repair functions of the skin (b820)
3. Activity and Participation
 - a. Carrying out daily routine (d230)
 - i. Managing one's own activity level (d2309)
 - b. Handling stress and other psychological demands (d240)
 - c. Speaking (d330)
 - d. Change basic body position (d410)
 - e. Maintaining a body position (d415)
 - f. Transferring oneself (d420)
 - g. Walking (d450)
 - h. Caring for body parts (d520)
 - i. Dressing (d540)
 - j. Intimate relationships (d770)

Standard of Care:

Physical Therapy Management of the Patient with a Mechanical Circulatory Support Device

- k. Work and employment (d845)
- l. Community life (d910)
- m. Recreation and leisure (d920)
- n. Sound (e250)
- o. Air quality (e260)
- p. Support and relationships
 - i. Immediate family (e310)
 - ii. Friends (e315)
- q. Individual attitudes of friends (e420)

Contraindications / Precautions for Treatment:

The most common medical and surgical complications associated with VAD therapy include hemorrhage, hemolysis, thrombosis, stroke, infection, device malfunction, arrhythmias, renal dysfunction, hypotension, respiratory dysfunction and hepatic dysfunction.^{9,11} When only one ventricle of the heart is supported (i.e. LVAD) there is the potential for contralateral ventricular failure.^{6,7} Please refer to the cardiac standard of care for general precautions and contraindications for treatment of the cardiac surgery patient.

Sternal precautions apply for all patients who have had a midline sternotomy.

- Refer to the cardiac standard of care for specific precautions.

Physical therapy (PT) intervention may need to be modified in the following situations:

- Infections tend to occur early in the VAD course, generally developing in the first 2 months after implantation. A study of 4,124 patients following discharge from an acute care setting reported that 1,253 (30%) had major infections. Of those 1,253 patients 42.1% were related to localized (non-device) related infection, 41.2% were related to site/pocket infection, and 16.2% were related to sepsis.¹² The most common organisms found in VAD related infections include coagulase-negative staphylococci, *S. aureus*, *Enterococcus* species, gram-negative bacilli and *Candida*.¹³ Infections are evidenced by fevers, increased white blood cell counts and radiographic evidence on chest or abdominal CT scan. Infections may be difficult to diagnose and may lead to increased bleeding and thrombotic complications.¹²
- Arrhythmias, specifically atrial fibrillation and ventricular tachycardia, may not be an absolute contraindication to PT treatment. Ventricular tachycardia may be treated with antiarrhythmic medications in the case of an LVAD. In the case of a biventricular assistive device, arrhythmia may be well tolerated by the patient.^{14,15} Conversations with the medical team or nurse regarding the physiologic and hemodynamic status of the patient may be necessary. Staff should monitor for symptomatic response to arrhythmia or hemodynamic instability/intolerance.
- Thrombotic related events including neurological dysfunction, pump thrombosis or hemolysis can occur following VAD implant.¹²

Standard of Care:

Physical Therapy Management of the Patient with a Mechanical Circulatory Support Device

- Orthostatic hypotension can often manifest itself through 1) a rise in native heart rate or VAD rate, 2) a drop in systolic blood pressure or mean arterial pressure (MAP), 3) a drop in VAD flow, 4) a decrease in VAD pulsatility index, or 5) a drop in TAH fill volume and/or cardiac output depending on device in use. Treatment considerations are similar to any patient with hypotension and include the use of lower extremity compression garments (i.e. antiembolism stockings, elastic wrap bandages), abdominal binders, deep breathing, lower extremity exercise and supine repositioning with lower extremity elevation.
- Any new VAD alarms or VAD malfunction
- Anticoagulation during long term VAD therapy is essential for prevention of thromboembolic and bleeding complications. The International Normalized Ratio (INR) goal will depend on the type of device and the patient's past medical history, and should be discussed with the VAD healthcare team.¹⁶ Partial thromboplastin time (PTT) should also be monitored while patients are on Heparin for short term anticoagulation.

Initial Mobility Considerations:

- When mobilizing patients early in their recovery, while they are in the cardiac ICU, it is important to monitor all lines and tubes, paying special attention to pulmonary artery (Swanz-Gans) catheter and left atrial catheter restrictions. Close monitoring of all vital signs and MCS numbers is also very important.

Cardiopulmonary resuscitation (CPR) may or may not be effective in the patient with a VAD. Please refer to appendices A through F for device specific emergency procedures.

Many device-specific precautions and contraindications also exist within the VAD population. Please refer to appendices A through F for device-specific precautions and contraindications.

Evaluation:

1. Medical History:

- a. Cardiac risk factors
- b. Onset and duration of cardiac symptoms
- c. Cardiac Diagnosis
- d. Length of cardiac history
- e. Extent of prior cardiovascular interventions

- 2. History of Present Illness:** Include if the MCS was placed emergently or electively, the type of MCS placed, which ventricle(s) is/are supported, manufacturer, goal of MCS therapy (i.e. destination therapy, bridge to transplantation), complications during the perioperative or postoperative period, pertinent lab values, significant diagnostic tests, dates of physical and occupational therapy (OT) consults, date of abdominal binder fitting by OT, and any response to activity with RN/medical staff (i.e. flows drop with bed mobility, etc.)

Standard of Care:

Physical Therapy Management of the Patient with a Mechanical Circulatory Support Device

3. **Social History:** Patient's prior level of function, prior use of an assistive device, level of endurance, home environment, barriers, family/caregiver support available, patient's expectations of returning to home and their life goals.
4. **Medications:**
 - a. Medications on admission (i.e. home inotropic support)
 - b. Medication requirements perioperatively, including vasopressors, beta blockers, ACE inhibitors, calcium channel blockers, diuretics, and pain medications
 - c. Current medications
 - d. Medication effects on rehabilitation therapies

Examination:

Please refer to the Cardiac Medicine & Surgery Standard of Care for all examination techniques related to the general cardiac patient.

1. **Observation**
2. **Hemodynamics:** A patient's native heart rate will be demonstrated on telemetry unless the patient has a TAH in which case the rate is set by the device. The therapist should note this rate, but be aware that the VAD rate will be different and is a more reliable rate for the patient's status as it directly controls all peripheral flow and cardiac output. Taking a radial pulse will monitor peripheral flow, and will therefore be a reflection of VAD rate in a patient with a pulsatile device. A pulse oximeter will also reflect VAD rate, not the native heart rate. A pulse oximeter will not be able to detect VAD rate or oxygen saturation in a patient with a pulseless device. In axial flow pumps, BP is often difficult to auscultate. In the ICU, BP may be monitored with an arterial line, however once the arterial line is discontinued, the standard of care is to monitor mean BP by Doppler.¹⁷ In patients with a pulsatile device, BP can be measured via sphygmomanometer and stethoscope. Not that there may be a blunted BP response to exercise in patients with TAH.
3. **Current Lab Values**
4. **Abdominal Binder:** All patients should be fitted with a binder by OT prior to initiation of out of bed activities. This binder may be custom made, or a prefabricated binder issued by any of the MCS D companies. The binder provides immobilization of the percutaneous drive line to promote wound healing between the epithelium and the fabric of the driveline, and prevent infection.²⁰ The binder should be worn at all times, including during sleep.²⁰ Ensure proper binder fit and adequate security of drivelines prior to mobility.
5. **Power Source:** The patient's MCS D may be connected to a power based unit (i.e. AC power from wall source) or may be reliant on battery support. It is important to know the current battery life of the MCS D prior to initiation of physical therapy services. See appendices for specific instructions on different devices
6. **Pain:** (location, duration, intensity), use of Visual or Verbal Analog Scale 0-10,²¹ and any action taken (i.e. RN notified of patient's pain, patient pre-medicated)
7. **Posture**

Standard of Care:

Physical Therapy Management of the Patient with a Mechanical Circulatory Support Device

8. Sensation

9. Strength/Muscle Performance

10. Range of Motion

11. Functional Mobility

- a. Patients should be progressed as with any acute care patient. Early mobilization of patients, including positioning, bed mobility and transfers should be initiated as early as post-operative day 1 in the intensive care unit pending medical stability.^{22,23}
- b. Current recommendations suggest that patients with VADs should be out of bed to chair and beginning ambulation with assistance by postoperative days 3-5.²⁴ It is suggested that patients with VADs should progress to independent ambulation and stair climbing with physical therapy by postoperative days 12-14.²⁴

12. Gait: Note if the patient is ambulating on battery support or with a AC power based unit, and note if the patient is pushing their own MCS D or if they need assistance

13. Endurance

- a. **Rate of Perceived Exertion**¹⁵ is an effective method of determining exercise parameters in correlation with vital sign and MCS D response
- b. **Six Minute Walk Test**^{25,26} can be initiated in the patient with a VAD as medically appropriate. The percent of age predicted walking distance per Enright et.al. or Gibbons et.al. should be recorded in the medical record.^{27,28}
- c. Current literature suggests that an endurance program for a patient with a VAD should include the following:
 - i. Interval ambulation (i.e. 2 min x5) initiated by postoperative days 9-11.²⁴
 - ii. A treadmill walking program by days 12-14 prescribed by modified treadmill ramp protocol depending on the device and patient's level of medical stability.^{24,29}
 - iii. Cycling, which may begin by postoperative week 3, should begin with 50 watts and increased by 25 watts as tolerated by patient
 - iv. Exercise should be progressed by 5 minutes each week for a total of 50 minutes of exercise 4-5 times per week by postoperative week 6.²⁴

14. Balance: Note alterations in balance when on battery power or when pushing a portable driver

15. Positioning: Including drive lines and abdominal binder.²⁰

16. Skin Integrity:

- a. Surgical wound appearance and driveline sites, skin breakdown from prolonged immobility pre and post-op.

17. Lines and Tubes:

- a. MCS D drive lines,²⁰ location of inflow and outflow cannulas (external device), attachment to AC or battery power
- b. Peripheral IV lines, Internal Jugular IV lines, Central IV lines, Pulmonary Artery (Swanz-Gans) line, Left Atrial line, nasogastric tube, chest tubes, telemetry, Foley catheter, rectal tube, oxygen delivery, Velitri
 - i. Be aware of mobility restrictions for those who continue to have a PA or

Standard of Care:

Physical Therapy Management of the Patient with a Mechanical Circulatory Support Device

LA line.

- 18. Cognitive-Perceptual and Psychological Considerations:** If the patient has undergone elective MCSD placement, a pre-operative cognitive evaluation is often completed by the occupational therapist (OT), and can be helpful in post-operative management and education³⁰
- a. The psychological implications of MCSD placement: note the patient's ability to cope with body image changes, altered functional status, fear or anxiety regarding the mechanical device, fear of upcoming transplant, fear or anxiety around retuning to previous life roles, burden of awaiting transplant and end of life issues.
 - b. Consider the patient's goals and motivators, the patient's learning style and preferred method of information delivery. There are many forms of MCSD education including videos, books, one-on-one conversation with the MCSD nurse practitioner and hands-on practice with supervision from the nurse or nurse practitioner.
 - c. Family stress, major depression, organic mental syndromes and serious adjustment disorders occur more frequently in patients with medical complications and significantly impairs rehabilitation. Aggressive treatment of depression in the MCSD patient may improve functional status.⁴
 - d. Note any cognitive changes related to peri-operative or post-operative neurological events as described above as potential complications.

Assessment:

The primary goal for inpatient physical therapy for a patient status post VAD placement is to maximize the patient's functional independence and safety prior to discharge from the hospital. If discharge home is not feasible, the goal of inpatient physical therapy intervention is to maximize their independence and endurance while on VAD at Brigham and Women's Hospital prior to discharge to a local extended care facility specifically trained to care for patients with VADs. Brigham and Women's Hospital has partnered with Spaulding Hospital and Rehabilitation Center in Cambridge to provide continued rehabilitative services after discharge from the acute care setting. If patient remains in house following MCSD implantation while awaiting heart transplant, goal is to optimize physical functioning and endurance in anticipation of cardiac transplant.

Standard of Care:

Physical Therapy Management of the Patient with a Mechanical Circulatory Support Device

- **Body Changes**

Potential body structure changes include, but are not limited to: median sternotomy, integumentary incisions, and cardiovascular and pulmonary system deconditioning. Potential body function changes may include, but are not limited to, cardiac and pulmonary pumps, aerobic capacity/activity tolerance, circulation, muscle performance, balance, and knowledge related to incisional precautions as well as knowledge regarding the operations of the MCSDD, and recommendations regarding mobilizing and exercising with the new MCSDD.

- **Prognosis**

The predicted optimal level of improvement for these patients is to return to their home environment demonstrating independence in all areas of function including gait with the MCSDD, with assistive devices as needed, and independence with management of their MCSDD device at rest and during daily activities and exercise. Patients should be able to return to their previous roles & lifestyles, although some modifications will likely be necessary because of the MCSDD. It is reasonable to expect patients to be at their maximum level of independence within 6-8 weeks of MCSDD placement. This prognosis may be altered in the event of any comorbidities, complications or secondary impairments. Environmental factors such as home set up, and psychosocial consideration such as their available support network will also impact home management of the MCSDD, and may alter functional capacity and participation. At Brigham and Women's Hospital the post- VAD median length of stay was 20 days in 2008. A recent study published in 2014 determined that early mobilization in patients with LVAD implantation was a good predictor of shorter length of stay in the hospital along with discharge home versus another acute setting. Of the 98 patients in the study, the mean length of stay was 35.4 days, 67 discharged to home settings, 22 discharged to rehab settings and 9 patients died. Of the 67 that discharged to home, the mean length of stay was 29.9 days and the average amount of days until first ambulation post implant was 4.1 days (compared to the 21.2 days for those who went to rehab). In addition, at time of discharge, approximately 84 percent of patients who were able to go home were able to ambulate with less than minimal assistance, compared to the 21 percent of patients discharged to rehab who were able to ambulate with less than minimal assistance.⁵

Goals:

Potential goals for safe discharge home:

Body Structure/Function:

The patient will demonstrate range of motion within functional limits in bilateral upper extremities and lower extremities.

The patient will demonstrate upper and lower extremity strength to maximal ability within their sternal precautions

Standard of Care:

Physical Therapy Management of the Patient with a Mechanical Circulatory Support Device

Activity:

The patient will be independent in all functional mobility including bed mobility, transfers, ambulation and stair training with their VAD

The patient will be independent in all VAD management and monitoring during functional activities

Participation:

The patient will be independent in all VAD management and monitoring during an independent exercise program

The patient will utilize VAD support group for support with community reintegration

Treatment Planning / Interventions

Established Pathway ___ Yes, see attached. X No

Established Protocol ___ Yes, see attached. X No

Interventions most commonly used for this case type/diagnosis.

This section is intended to capture the most commonly used interventions for this case type/diagnosis. It is not intended to be either inclusive or exclusive of appropriate interventions.

Physical Therapy is typically consulted to see the VAD patient immediately post-operatively. It is the therapist’s responsibility to assess each patient’s appropriateness for beginning a PT program. Patients who have undergone VAD placement are typically seen for the following interventions:

Therapeutic Exercises: Physical Therapy with a VAD patient often begins in the ICU with passive or active assisted ROM exercises, advancing to active ROM exercises as the patient’s strength improves. Exercises typically progress from supine, to sitting, to standing. Patients are issued a Phase One Cardiac Rehab Exercise program which includes a daily walking and therapeutic exercise program.

Endurance Training: Systemic cardiac output has been shown to increase after LVAD implantation because the left ventricle is able to eject blood through the native aortic valve and increase blood output in parallel with the VAD.^{31,32} Endurance training is accomplished by gradually increasing the time patients are able to participate in an activity. This is usually addressed initially through the progression of functional activities, gradually increasing the time the patient is out of bed to a chair or the distance a patient is walking. Stationary biking and treadmill use with close monitoring is also an option; however the position of the VAD may interfere with the ability to perform full hip flexion to allow for comfortable pedaling. Use of a restorator may be more practical in the VAD patient. Interval training is often utilized with

Standard of Care:

Physical Therapy Management of the Patient with a Mechanical Circulatory Support Device

exercises, functional activities or ambulation to increase endurance. In some cases, endurance and interval training via a treadmill protocol may be indicated.

Functional Mobility Training: Patients are progressed from bed mobility, to sit to stand and bed to chair transfers, to ambulation, to weaning assistive devices as appropriate, and finally to steps/stairs; all with independent management of their devices.

Mechanical Circulatory Support Device Management: During the course of physical therapy interventions, the patient and therapist should focus on increasing the patient's independence with the mechanical features of the MCS. The patient should progress to efficiently changing from AC to battery power, performing system checks, packing their "emergency" bag for ambulation and monitoring MCS hemodynamic response to activity. The patient may have to learn special techniques for maneuvering the MCS on the stairs and monitoring their exercise tolerance when conventional techniques do not apply. The patient will review emergency techniques with the nurse or nurse practitioner and should be proficient in these techniques with appropriate clinical documentation before being encouraged to ambulate independently by the therapy staff.

- **Frequency & Duration:** Frequency may vary during the patient's hospital course. Initial treatment in the ICU is often 3-5x/wk with frequency progressing to 5-7x/wk as discharge approaches. If the patient remains at BWH until transplant, their frequency of treatment may lessen as they achieve their PT goals and continue to be followed for optimization of endurance and function leading to transplant. They may be discharged from acute PT services and perform an independent program daily, with supervision as needed from the nursing staff or their family while they remain at BWH.

- **Patient / family education**
 - Instruct patient in appropriate pacing techniques
 - Instruct patient about sternal precautions
 - Patients should be taught to understand their own MCS numbers at rest, and how they should respond to daily activities, self care and exercise
 - In conjunction with the MCS team, review with the patient how to check their battery life prior to mobilization
 - In conjunction with the MCS team, review emergency equipment and procedures
 - Review equipment that should be carried with them during ambulation or time out of their room
 - Instruct patient in independent therapeutic exercise program
 - Instruct patient in home exercise/activity program including a therapeutic exercise program and a cardiopulmonary endurance program (walking, biking)
 - MCS patients who experience abdominal discomfort related to the MCS may benefit from education regarding stretching, positioning, and bracing in the abdominal region

Standard of Care:

Physical Therapy Management of the Patient with a Mechanical Circulatory Support Device

Handouts

BWH Guidelines after Cardiac Surgery

BWH VAD Handbook (created by VAD Nurse Practitioners, supplemented by PT and OT)

Recommendations and referrals to other providers

Treatment of the VAD patient is a multidisciplinary approach with a specialized group of cardiologists, cardiac surgeons, and nurse practitioners. Referrals to other disciplines at BWH often include:

Occupational Therapy (OT): OT is often consulted pre-operatively to assess cognitive function and ability to learn in the case of elective MCS placement. Long term low cardiac output in the heart failure patient impacts end organ function through decreased blood flow. Studies have shown moderate to severe cognitive and neuromotor impairment in up to 60% of patients with heart failure. These patients can show impairments in mental processing speed, memory, motor speed and grip strength. More pronounced levels of these impairments were noted in the patients who required mechanical assist devices³⁰. Hand weakness and dyscoordination may lead to difficulty in independent manipulation of MCS parts. This can often be identified and treated by an occupational therapist prior to elective MCS surgery with an independent exercise program. OT is also consulted immediately post-operatively for all MCS patients to measure the patient for a custom made or prefabricated abdominal binder. A full OT evaluation is completed once the patient is medically stable to assess upper extremity motor skills, ADLs and cognitive skills.³³ In a recent study, VAD patients have reported difficulties performing self-care activities which OTs at Brigham and Women's Hospital routinely assess during evaluation and treatment sessions.^{34,35}

Social work: At BWH there is a specific social worker who specializes in the care of patients in the heart failure program. The social worker follows these patients during admissions for heart failure, admissions for MCS placement and any subsequent admissions, up to and including admissions around cardiac transplantation if applicable.

Chaplaincy and/or Psychiatry may need to be involved in the treatment of this patient population due to the severity of the patient's illness, the effect on family dynamics, body image, life roles and potential end of life issues. Shapiro, et al noted that psychiatric problems most often occurred in patients who had complications following VAD placement, and that aggressive treatment of depression may help improve functional status.⁴

Speech and Swallow Services: Speech and swallow therapy may be involved in patients who present with significant weakness related to preoperative heart failure, long intubations and bed rest. A bedside speech evaluation will be completed to determine appropriateness of a video swallow evaluation, prior to initiating food/liquid by mouth. Speech Therapy can also provide assistance with speech and language in the event of a perioperative CVA.

Standard of Care:

Physical Therapy Management of the Patient with a Mechanical Circulatory Support Device

Care Coordination: The cardiac surgery care coordinators aid in setting up home care services when the MCS D patient nears discharge home. Home nursing services are initially needed for dressing changes and blood draws. The care coordinators can also set up transfer to Spaulding Hospital for Continuing Medical Care in Cambridge, Massachusetts.

VAD/MCS D Support Group: Support group meets twice a month. Patients generally come to the BWH VAD clinic and meet with their doctors and nurses in the morning, followed by support group in the early afternoon. The social worker runs the support group, and the VAD nurse or nurse practitioners (NPs) are generally present. Many current VAD patients, and occasionally some heart transplant patients who have had VADs in the past, are involved in the support group. The group is open to all current VAD patients, whether inpatient or outpatient, and their families. Often times a patient may still be in the ICU, but the family members are able to begin participating in support group. All inpatients are encouraged by the VAD team to attend when hemodynamically stable. Rehab therapists schedule treatment sessions around the meeting of support group, as attending support group is considered a vital part of the VAD program and the patients overall recovery process. Supportive care by social workers and mentoring by prior VAD patients in a support group has been suggested as a way to improve quality of life in the weeks following VAD implantation.^{34, 35}

Re-evaluation/Re-assessment

Reassessment will occur every 7-10 days following initial evaluation or most recent assessment, but may also occur due to any of the following circumstances: all physical therapy goals are met, there is a significant change in the patient's medical status, the patient is discharged from acute PT services, or the patient is discharged from Brigham and Women's Hospital.

Discharge Planning

Discharge planning for the MCS D patient is a multidisciplinary approach. The patient going home with a new MCS D has to demonstrate knowledge of handling the device on a daily basis and in emergency situations to the MCS D team. Their family members/caregivers must also be able to demonstrate these procedures before the patient can safely be discharged from BWH. The MCS D team provides education regarding operation of the MCS D, troubleshooting alarms, exit site wound care, and post discharge follow up care. Community support for medical or power failure emergencies is necessary when a MCS D patient goes home. The patient's local fire departments, emergency medical technicians (EMTs), and emergency room physicians are trained in emergency procedures of the MCS D by the team. The local power company is also alerted to the need for early return of power in the case of power loss. VAD patients' perceptions of being unable to care for themselves after surgery may be alleviated with educational programs as mentioned above.^{34, 35}

The uncomplicated VAD recipient is discharged to home within weeks of VAD placement, however many times their hospital course may be extended due to complications. Upon discharge from BWH, most individuals do not require follow-up physical therapy. Patients have

Standard of Care:

Physical Therapy Management of the Patient with a Mechanical Circulatory Support Device

been instructed in their individualized home exercise program, including a cardiopulmonary endurance training program. They have also been instructed in the correct way to advance their own program, and will therefore be able to progress on their own. The VAD team is readily available to these patients if they have any questions. The services of home physical therapy can be available as needed through many homecare agencies.

In the event that a patient with a MCSD is unable to be discharged home due to functional limitations and/or medical complexity, Brigham and Women's Hospital has a working relationship with Spaulding Hospital for Continuing Medical Care in Cambridge, Massachusetts. It should be discussed as early as possible with the healthcare team should the need for a rehab stay be anticipated. In the case of discharge to Spaulding Hospital for Continuing Medical Care in Cambridge, the MCSD team coordinates staff education at the receiving hospital, and the Cardiac Surgery Care Coordinator facilitates discharge arrangements. Complex MCSD discharge situations should be discussed with a mentor therapist and the MCSD team.

Patient's discharge instructions

Patients are discharged from physical therapy services when they have met all short term goals for safe discharge home. Patients may require assistance from their families or caretakers with MCSD management, and physical therapists should take this into consideration when creating patient goals. A family teaching session prior to discharge from physical therapy services is generally warranted for patient and family safety. Patients must also demonstrate competence in monitoring the MCSD during exercise and demonstrate appropriate modifications of their exercise program based on their response to exercise.

Patients and their families are discharged home after extensive teaching with the MCSD team. The nurse practitioners will complete the majority of discharge teaching, and the nursing staff will reinforce the teaching on a daily basis. Some discharge teaching may be done with the physical therapist, but great care should be taken to ensure accuracy and consistency of information. The patient will receive a MCSD log book prior from the team prior to discharge home. Each log book is device specific and includes emergency contact information, a troubleshooting guide, the device manual, flow sheets for tracking MCSD numbers, a medication flow sheet, flow sheets for tracking weight, blood pressure and temperature, and wound care information. Information from other disciplines (i.e. PT, OT and nutrition) will also be included. The log book also includes a discharge checklist which should be completed by the nurse practitioner prior to discharge to ensure that all necessary information is covered. Physical therapy should provide any necessary exercise and sternal precaution handouts and pertinent contact information.

Author:

P. Newman, PT
03/2015

Reviewed by:

J. Rydingsward, PT
M. Tagerman, PT
N. Russell, PT

Standard of Care:

Physical Therapy Management of the Patient with a Mechanical Circulatory Support Device



BRIGHAM AND WOMEN'S HOSPITAL

Department of Rehabilitation Services

Physical Therapy

Standard of Care: Mechanical Circulatory Support Device

Appendix A

Thoratec® PVAD™ and TLC II® Portable Driver



Reprinted with permission from Thoratec Corporation

Indications for use

- Left, Right, or Biventricular failure
- Lethal arrhythmias
- Bridge to transplant or post-cardiotomy recovery
- Those who do not qualify for other devices due to:
 - Small body habitus- less than 1.5m², but larger than 0.73m² body surface area (BSA)
 - Mechanical Aortic Valve

Standard of Care:

Physical Therapy Management of the Patient with a Mechanical Circulatory Support Device

Paracorporeal VAD (PVAD™)

- Paracorporeal device that can centrally or peripherally cannulated
- A prosthetic ventricle with smooth chamber enclosed in a hard case
- Two mechanical valves maintain unidirectional flow
- The pumping chamber is separated from an air chamber by a polyurethane diaphragm
- The fill switch determines when the VAD is full of blood and sends the fill signal to the drive console



Support & Cannulation (Figure 2)

- Can provide left, right or biventricular support
- In left heart support the inflow cannula allows blood to travel from the left atrium or the left ventricle into the pump, and the outflow cannula allows blood to travel from the pump and out to the aorta
- In right heart support the inflow cannula allows blood to travel from the right atrium into the pump, and the outflow cannula allows blood to travel from the pump and out to the pulmonary artery

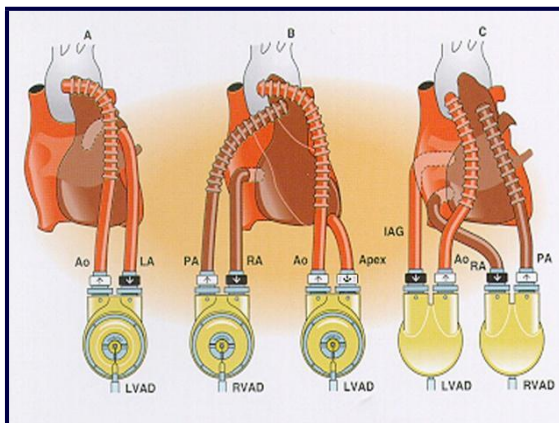

Figure 2
Examples of Cannulation
Reprinted with permission from
Thoratec Corporation

Standard of Care:

Physical Therapy Management of the Patient with a Mechanical Circulatory Support Device

- With atrial cannulation, there is minimal myocardial damage and cardiopulmonary bypass is not necessary, but lower VAD flows are achieved
- With ventricular cannulation, there are higher VAD flows and lower risk of thromboembolism

Dual Driver Console (DDC) (Figure 3)

- Contains two identical, independent drivers labeled LVAD and RVAD if the patient is on biventricular support
- Modes are “asynchronous” or “volume”
 - “Asynchronous” mode allows a set rate
 - “Volume” mode allows the VAD chamber to empty only when completely filled with blood (variable rate)
- Percent systole is the ejection time (in milliseconds) the VAD takes to eject the blood (i.e. 300 milliseconds)
- Drive Pressure: Ejects blood from the VAD
 - LVAD 230-245mmHg
 - RVAD 140-160mmHg
- Vacuum: Assists with VAD filling, generally -25 to -40 mmHg



Figure 3

Dual Driver Console

Reprinted with Permission from
 Thoratec Corporation

Standard of Care:

Physical Therapy Management of the Patient with a Mechanical Circulatory Support Device

DDC Alarms

- Pressure Alarm
 - Occurs when ejection pressure is below 100mmHg or above 250 mmHg
 - If alarm sounds during PT treatment, notify VAD team
- Vacuum Alarm
 - Occurs when vacuum is less than +4 mmHg or greater than -90mmHg
 - If alarm sounds during PT treatment, notify VAD team
- SYNCH Alarm
 - When alarm occurs, -E- is displayed on the DDC instead of the VAD output
 - VAD rate drops to the back-up rate
 - Potential Causes
 - Poor VAD filling (hypovolemia, RV failure, tamponade, vacuum too low, cannula or pneumatic hose kinked)
 - Rate set too high
 - Drive pressure <100mmHg
 - Ejection time <250msec
 - % systole too high, resulting in too short filling time
 - Fill cable (grey) malfunction or disconnection
 - Fill switch or module failure
 - When the outflow cannula is in the right atria, -E- may occur with standing as gravity sends blood to the right ventricle rather than through the right atria to the VAD
 - If alarm sounds during PT treatment, notify VAD team
- Low Battery Alarm
 - Battery life is about 40 minutes
 - Charge indicated by the 5 lights on the front of the console
 - Intermittent alarm, beeps once per second when unplugged
 - Alarms when batteries have less than 30 minutes of power remaining
 - Red light and continuous sounding alarm when less than 5 minutes of battery life remains
 - DDC requires 24 hours to fully recharge the battery

Standard of Care:

Physical Therapy Management of the Patient with a Mechanical Circulatory Support Device

TLC II[®] Portable Driver (Figure 4)

- Small, portable, lightweight (9.8kg)
- Less ability to change settings than DDC
 - Patients transitioned to this device when they have been stable on DDC
- Uses Lithium Ion (Li-Ion) Rechargeable Batteries
 - 55-80 minutes of power per battery when used as BiVAD
 - 120 minutes of power per battery when used as left or right VAD
 - Batteries have 5 green lights indicating amount of charge left
 - Battery status is continually monitored
 - When one battery is depleted, power will switch to the other battery. A single audio chirp will sound and the yellow indicator light will illuminate for the battery in use.
 - An audible alarm occurs in 30 second interval if only one battery source is available
 - A continuous alarm occurs when there are 10 minutes or less of battery life remaining and the control panel will display “< 10 MINUTES LEFT”
 - Battery Charger can fully recharge batteries in 2 hours
- Use of the TLC II[®] requires a drive pressure setting of less than 170 mmHg on the RVAD. Medication adjustments by the medical team may be necessary to achieve this.



Standard of Care:

Physical Therapy Management of the Patient with a Mechanical Circulatory Support Device

Modes of Operation on TLC II®

- Fixed mode sets the ejection frequency at a fixed rate
 - Asynchronous from the native heart rate
 - Used for initializing settings after surgery
 - Used for weaning from the device if explanation may be possible
- Volume mode sets ejection frequency by filling of the blood chamber
 - Rate automatically responds to the changes in physiologic conditions
 - Once the pump fills completely, the fill switch signals to the drive console to eject the blood
 - As preload (atrial pressure) increases, the pump fills faster and the rate of output increases
 - As preload decreases, the pump fills more slowly, and the rate decreases

TLC II® Heart Touch® Tablet (Figure 5)

- Wireless, touchscreen tablet that communicates with TLC II® Driver
- 30 meter (98.4ft) range from patient/device via a wireless adapter
- Capability of downloading log data and waveforms to a thumb drive
 - Log data includes:
 - Main screen information- VAD rate and flow, status of power sources, and alarm information
 - Plots- real-time graphs of pneumatic drive pressure waveforms
 - Lists- main screen information in list form arranged by time
 - VAD settings- allows changing settings/parameters
 - General- patient information, set time, screen calibration, retrieve event data
 - Technical

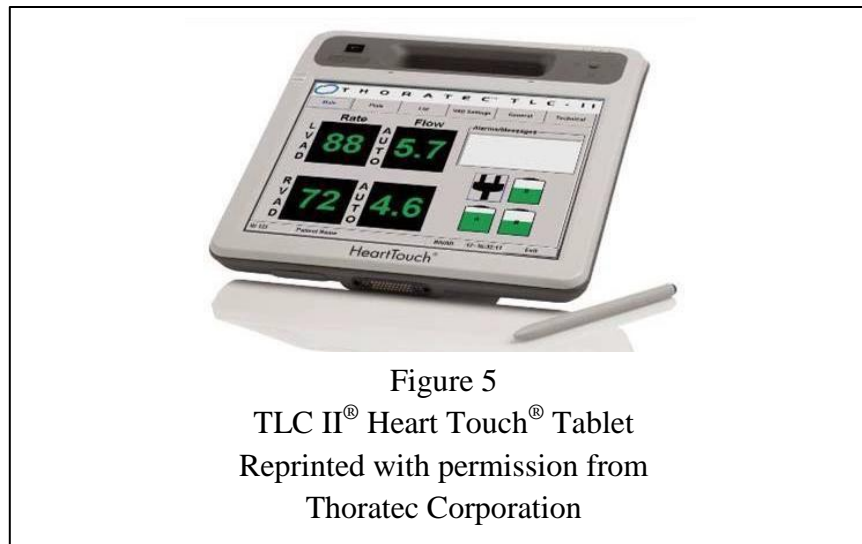

Standard of Care:

Physical Therapy Management of the Patient with a Mechanical Circulatory Support Device

Flash Test (Figure 6)

- This is only way to determine if the pump is emptying completely with each beat
- In a patient with a PVAD™, the pump is lifted slightly and a flashlight is shined through the pump, which should illuminate a “flash” on the surface below



Figure 6
Flash Test

Photo courtesy of Catherine Saniuk RN, MS, CCRN
Brigham and Women's Hospital

Emergency Procedures in the event of Pump Failure- Hand Pumping

- Assess the patient
- Connect drive lines to hand bulbs (blue)
- Squeeze bulbs manually at approximately 60 bpm
- In the case of biventricular support, always empty (squeeze) LVAD first to avoid pulmonary hypertension
 - Never pump the RVAD faster than the LVAD

Standard of Care:

Physical Therapy Management of the Patient with a Mechanical Circulatory Support Device

Binder (Figure 7)

- Created and fit by OT as soon as medically stable
- Wedges provided to keep warm pump off patient's skin, avoid kinking of drive lines



Figure 7

Thoratec® PVAD™ Binder with Wedges

Photo courtesy of Catherine Saniuk RN, MS, CCRN
Brigham and Women's Hospital

Anticoagulation

- Heparin dosage with goal to maintain PTT 75-80
- Warfarin dosage with goal to maintain INR 2.5-3.5
- May need Plavix if platelet count greater than 300,000

Rehab Considerations:

- When leaving the room with the TLC II®, the patient should carry an extra battery, one or two hand pumps for uni- or bi-ventricular support respectively and a TLC-II® AC adapter
- A balance assessment should be completed prior to initiation of ambulation pushing the portable TLC II® driver due to the unstable nature of the TLC II® driver
- The patient should be instructed on how to monitor VAD rates and flows during activity

Standard of Care:

Physical Therapy Management of the Patient with a Mechanical Circulatory Support Device



Standard of Care: Mechanical Circulatory Support Device
Appendix B
HeartMate II® Left Ventricular Assistive Device (LVAD)

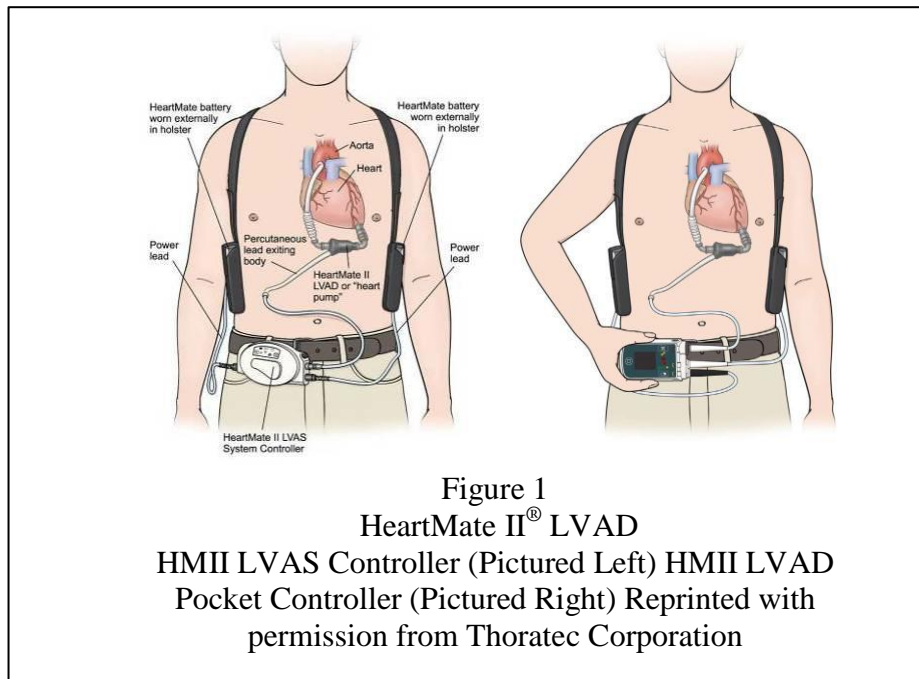

Overview

- FDA approved for bridge to transplant or destination therapy
- Goal is for discharge home
- Most patients have BSA $>1.5\text{m}^2$ but the possibility for implantation in patients with BSA $<1.5\text{m}^2$ can be made on a case-by-case basis

The Pump (Figure 2)

- Valveless
- Preload and afterload sensitive
- Follows native pulse
- Pump output varies over the cardiac cycle
- The pump weighs about 10 ounces
- Flexible inflow cannula inserted in the left ventricular apex
- Outflow graft connects to aorta via flexible “bend relief” tubing
- Inflow and outflow cannulae have textured, thrombo-resistant surfaces

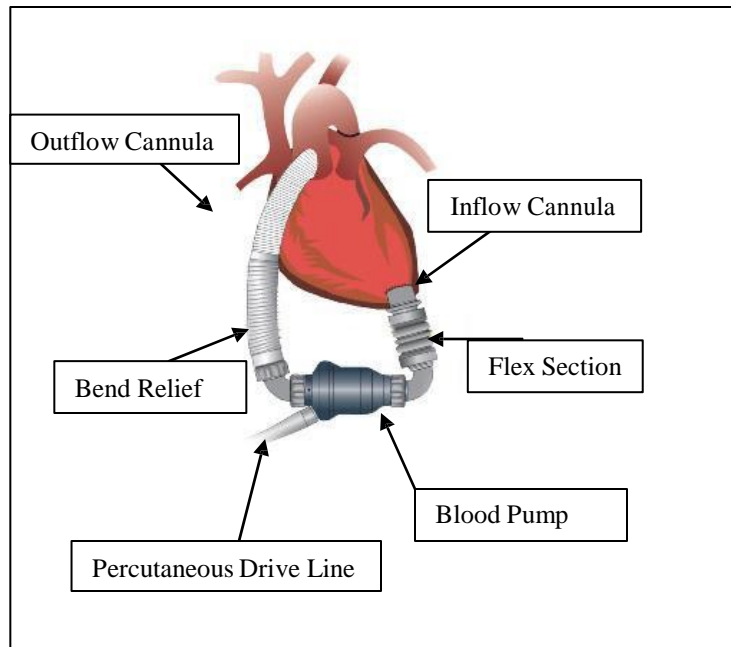

Figure 2
The HeartMate II[®] Pump
Reprinted with permission from Thoratec Corporation

The Rotor

- Spins on blood-lubricated bearings
- Driven by integrated electric motor which is outside the pump

Standard of Care:

Physical Therapy Management of the Patient with a Mechanical Circulatory Support Device

The Flow Path (Figure 3)

- Inflow comes from the left ventricle
- Inlet stator is designed to “straighten” the blood before it enters the rotor via three guide vanes
- The rotor propels blood forward and spins it radially
- When leaving, the flow is straightened by the outlet stator and pressure is increased

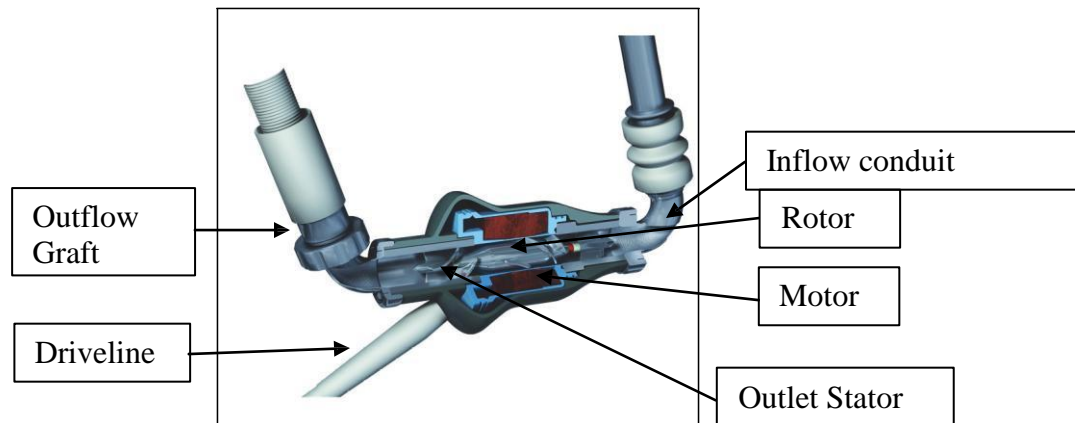

Figure 3
The Flow Path
Reprinted with permission from Thoratec Corporation

Flow Principles

- Flow is set by the speed of the rotor and the difference between the pressure in the ventricle and the aorta
 - A large difference in pressure gradient will cause low flow
 - A small difference in pressure gradient will cause high flow
- Any contraction of the heart creates a pressure pulse
 - Even a severely depressed heart will have some residual contraction
- With increased speed the pump offloads the ventricle further
 - This will cause more LV contraction
- An increase in pressure at the pump inlet (LV) will cause an increase in flow at the outlet (aorta)
- As speed increases, flow will increase
- As the pressure gradient increases, flow will decrease

Standard of Care:

Physical Therapy Management of the Patient with a Mechanical Circulatory Support Device

Pulsatility Index (PI)

- A measure of the flow pulse through the pump
 - Ventricle contraction increases flow across the pump
- In normal cardiac physiology, when preload increases in the LV, the force of contraction increases as described in the Frank-Starling relationship. In heart failure, the myocardium is overloaded such that the myocardial sarcomeres are overstretched to the point that they produce a less forceful contraction. As the VAD unloads the ventricle of a heart in failure, the length tension relationship improves and subsequently the force of contraction increases and PI increases. As the VAD continues to further unload the ventricle, the length tension relationship becomes sub-optimal and the force of contraction decreases, along with the PI of the ventricle (Figure 4)
- Pump speed determines the amount of LV unloading and therefore the pulsatility of the ventricle (Figure 5)
 - As speed increases, the PI decreases, indicating more LV unloading
 - As speed decreases, the PI increases, indicating less LV unloading
 - Goal PI 4.0

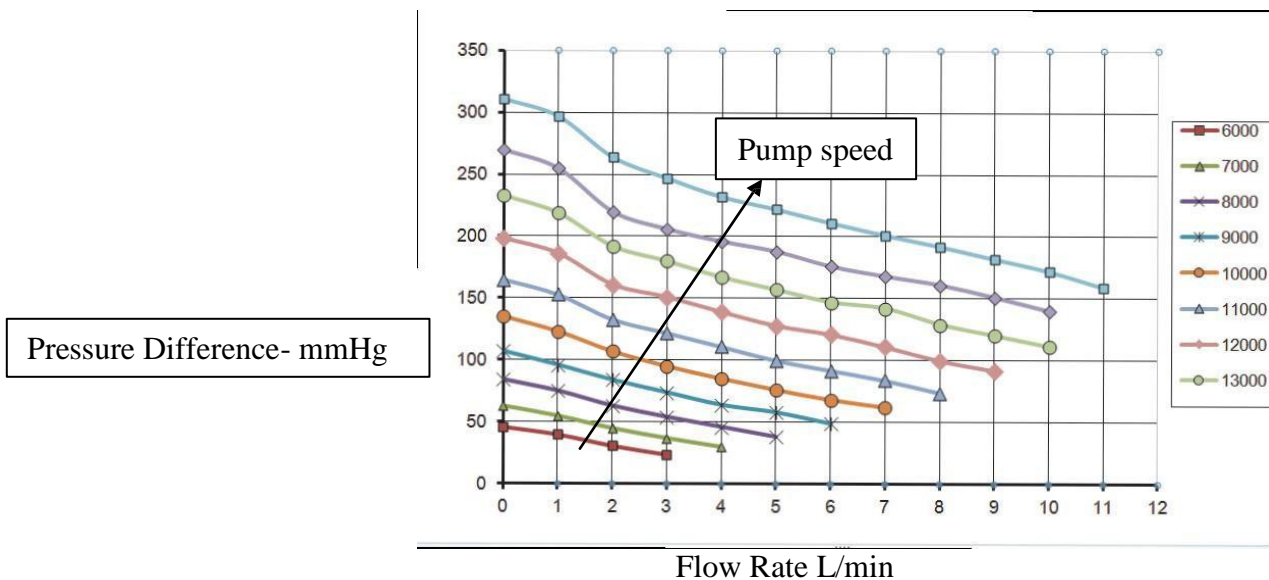

Figure 4
Pressure Flow Curve
Reprinted with Permission from Thoratec Corporation

Standard of Care:

Physical Therapy Management of the Patient with a Mechanical Circulatory Support Device

Pulsatility Index-speed ramp

Schematic of events as pump speed is steadily increased

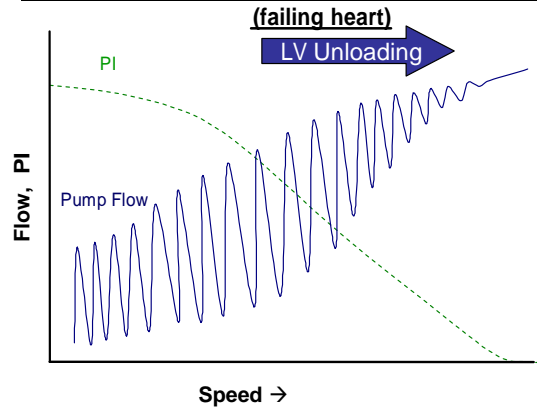

Rev. 12.0 (3/24/04)

HMII TRIAL

Figure 5
Pulsatility Index-Speed Ramp
Reprinted with Permission from Thoratec Corporation

Suction Event

- The system monitors sudden changes in pump flow pulsatility (PI event)
- When the PI event (low flow) is detected, the speed of the pump automatically reduces to the low limit setting to avoid suction
- The pump will slowly return to the set speed
- May cause ectopic beats
- Potential causes:
 - Dehydration or pump speed too high

Standard of Care:

Physical Therapy Management of the Patient with a Mechanical Circulatory Support Device

Typical Hemodynamics

- Fixed Speed = 6,000-15,000 rotations per minute (rpm)
- The flow estimator provides an estimate of pump flow, generally 3.0-6.0 L/min; flow should not be used to monitor the patient's status
- Power in watts
- Pulsatility Index generally 3.0 to 6.0 with goal of 4.0
- Blood Pressure will usually not be pulsatile enough to detect with direct auscultation or with an automatic sphygmomanometer. The clinician must use a manual sphygmomanometer with a doppler to obtain an estimation of the MAP
- MAP should be maintained less than 90
- CVP generally should be between 12-15
- Generally no O2 Saturation can be detected as blood flow is not pulsatile
- Anticoagulation via Warfarin and Aspirin for goal INR 2-3

Standard of Care:

Physical Therapy Management of the Patient with a Mechanical Circulatory Support Device

System Components

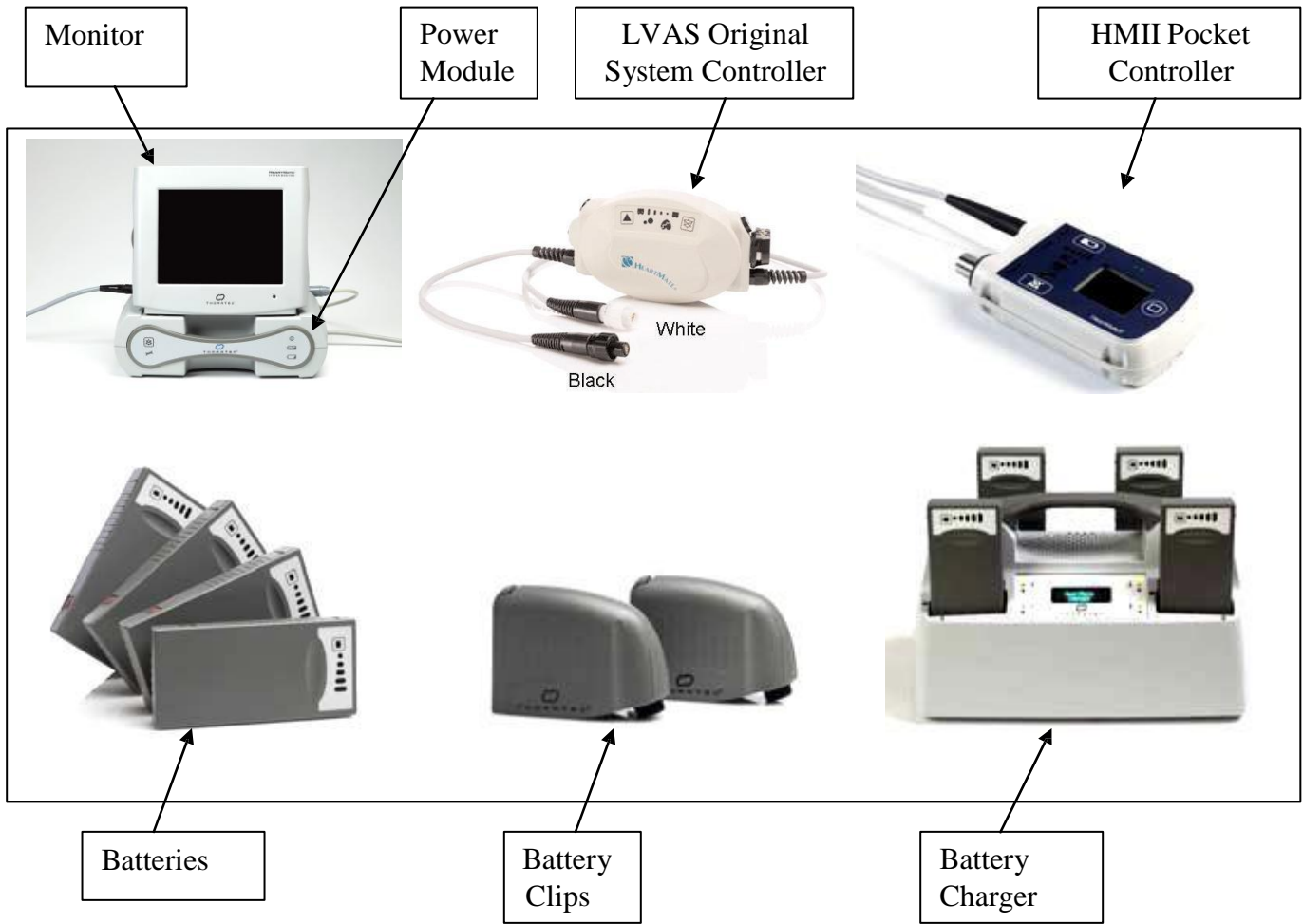

Figure 6
System Components
Reprinted with permission from Thoratec Corporation

Standard of Care:
Physical Therapy Management of the Patient with a Mechanical Circulatory Support Device

System Controller

- Controls pump speed and power
- Monitors and interprets data and responds to system performance
- Hazard and advisory alarms
- Fully redundant back-up system
- Automatic event recording
- Has a percutaneous lead connection which should be inserted all the way into the controller
- Latch guard should be in place to protect against accidental disconnect of percutaneous cable from system controller (pump would stop)
- Two Models
 - Pocket Controller
 - User interface LED display that can show VAD pump settings (speed, flow, PI, Power and charge status of backup battery)
 - Symbols for battery indicator, pump running, status, cable disconnect
 - Buttons for controlling display, silencing alarms and displaying battery power gauge
 - Internal 11 volt lithium-ion backup battery that can provide at least 15 minutes of backup power to the LVAD if external power fails
 - LVAS System Controller (Original Controller)
 - Buttons for controller self-test and silencing alarms
 - Icons to indicate battery power gauge, controller power, controller battery, red heart symbol, battery power source
 - System controller alarm battery provides limited power to the audible alarms in situations where external power has been disrupted. DOES NOT provide backup power to the controller or pump

Power Module (PM)

- Provides AC power to the LVAD when connected by a 20' power-based unit (PBU) cable
- Color coded connections
 - White connection- distributes VAD information to the PBU and display monitor
 - Black connection- only a source of power, no information communicated
- Indicates battery charge status, system malfunction, battery hazard via icons
- Interfaces with the display module

Standard of Care:

Physical Therapy Management of the Patient with a Mechanical Circulatory Support Device

Display Monitor

- Touch screen interface to allow the user to view and change settings
 - Clinical screen displays real-time mode, speed, flow, power and PI
 - Setting screen allows adjustment of pump parameters
 - Alarms screen shows history of alarms and alarm settings
 - Save data screen allows to change data recording parameters
 - History screen shows history of VAD settings and alarms
 - Admin screen allows for changing date, time, language, etc.
- The patient should be on the PBU any time they are sleeping
- Provides 30 minutes of back-up power in the event of power failure

Batteries

- Two 14 volt lithium-ion batteries with approximately 8-12 hours of power (as a pair)
- Battery clips are required to connect to the system controller or pocket controller
- Battery Status On the Battery (Figure 7)
 - 5 green lights = 80-100% power remains
 - 4 green lights = 60-80% power remains
 - 3 green lights = 40-60% power remains
 - 2 green lights = 20-40% power remains
 - 1 green light (steady) = 10-20% power remains
 - 1 green light (blinking) = <10% power remains (replace batteries one at a time)
 - No green lights = battery is in sleep mode due to being in storage for a long period of time. Charge battery immediately



Figure 7
Checking Battery Status Reprinted with
permission from Thoratec Corporation

Standard of Care:

Physical Therapy Management of the Patient with a Mechanical Circulatory Support Device

- Battery Status on the Controller
 - 4 green lights = 75-100% power remains
 - 3 green lights = 50-75% power remains
 - 2 green lights = 25-50% power remains
 - 1 green light = less than 25% power remains
- Battery Alarms
 - Less than 15 minutes of power remains, beeps once every 4 seconds
 - Less than 5 minutes of power remains, continuous tone, defaults to power saver mode and set speed of 8000 RPMs

Changing from PBU to Battery Power

1. Ensure that the connections between the LVAD driveline and the controller are intact
2. Connect the batteries to the right and left battery clips until the battery clicks into place (align arrows)
3. Disconnect white controller cable from power based unit and connect to battery and clip (See Figures 8 and 9)
4. Ensure connections are “hand tight”
5. Disconnect black controller cable from power based unit and connect to battery and clip
6. Ensure connections are “hand tight”
7. Never disconnect both cables at the same time. The pump will STOP!
8. Repeat procedure when returning to power based unit



Figure 8
HeartMate II® White Controller
Cable Disconnected
Photo courtesy of Catherine Saniuk
RN, MS, CCRN
Brigham and Women’s Hospital

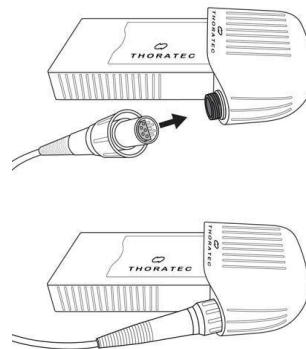

Figure 9
HeartMate II® White Controller
Cable Connected to Battery Clip
Reprinted with permission from
Thoratec Corporation

Standard of Care:

Physical Therapy Management of the Patient with a Mechanical Circulatory Support Device

Alarms on the controller

- Red Heart Alarm (steady audio tone)
 - Low flow
 - Pump has stopped working or is not working properly
 - Power disconnected from original system controller or pocket controller
- Red Battery (steady audio tone)
 - Less than 5 minutes of battery power
 - Low voltage
- Controller not getting enough power
- Yellow Battery/Yellow Diamond (1 beep every 4 seconds)
 - Less than 15 minutes of battery power remain
 - Low voltage
 - System controller not getting enough power from PBU
- Yellow Controller Cell (1 beep every 4 seconds)
 - Battery that powers the system controller audible alarm is depleted
- Rapidly Flashing Green Power Symbol (1 beep every second)
 - One of the power leads is damaged or disconnected

Special Situations

- In the case of backflow through the device, PT would note low flow or low speed alarm, likely due to dilated ventricle
- In the case of ventricular recovery, an increase in PI would be noted and, on ECHO, the aortic valve would open with every beat
- During exercise the PT should note an increase in PI due to increased venous return and increased ventricular contractility
- A rapid increase in power may be indicative of a clot in the system

Emergency Procedures in the Event of Pump Failure- Changing the controller

- Have the patient sit or lie down
- Attach 2 backup batteries to backup controller
- Unlock drive line sites on both controllers
- Disconnect drive line from non-working controller
- Insert the drive line into the backup controller

Daily Routines

- System self-test every morning
- Exit site wound care completed daily by nursing
- Custom abdominal binder or binder provided by the Occupational Therapist is worn at all times
- PT and OT programs
- Nutrition
- Discharge teaching with Nurse Practitioners

Standard of Care:

Physical Therapy Management of the Patient with a Mechanical Circulatory Support Device

Ambulation Checklist

- The patient carries a travel bag with emergency equipment (any time the patient leaves their hospital room) (Figure 10)
 - Spare controller
 - Spare controller battery (original system controller only)
 - (2) Spare batteries and (2) spare battery clips
- Fresh batteries are inserted prior to ambulation and the battery fuel gauge should be checked periodically during ambulation, on the controller



Standard of Care:

Physical Therapy Management of the Patient with a Mechanical Circulatory Support Device



BRIGHAM AND WOMEN'S HOSPITAL

Department of Rehabilitation Services

Physical Therapy

Standard of Care: Mechanical Circulatory Support Device

Appendix C

2nd Generation CentriMag[®]



Figure 1

CentriMag[®] System Components- Pump, Display and Console Tower with Mag monitor
and

Console and Motor

Reprinted with permission from Thoratec Corporation

Overview

- Extracorporeal short term blood pump
- Centrifugal pump
- Magnetically levitated impeller

Standard of Care:

Physical Therapy Management of the Patient with a Mechanical Circulatory Support Device

System Components

- Pump
 - Polycarbonate blood pump with impeller spinning in the “contact-free” chamber
- Motor
 - Applies both levitational and rotational magnetic force (bearingless) to drive the impeller inside the blood pump
- Console
 - Primary console used at the bedside daily
 - Backup console available to provide temporary life support should the primary console malfunction, this console does not have flow or pressure sensing capabilities, and the patient should be returned to a primary console as soon as possible.
 - Has digital read out of speed (RPM), flow (Liters per minute [L/min]), alarms and pressure
 - Buttons to view and adjust pump speed and alarms
- Mag Monitor
 - Displays flow and RPM
 - Ability to control flow, RPM and auxiliary settings
 - Stopwatches
 - Multicolor display that shows VAD settings and alarms
- Flow Probe (Figure 2)
 - Ultrasonic flow probe connected to the outflow cannula
 - Can detect flows from 0.9 to 9.9 L/min
 - Clip on design
 - Does not need calibrating
 - Repositioned once per shift to avoid memory kink on the tubing
 - Can detect retrograde flow, displayed as “---” instead of L/min on console

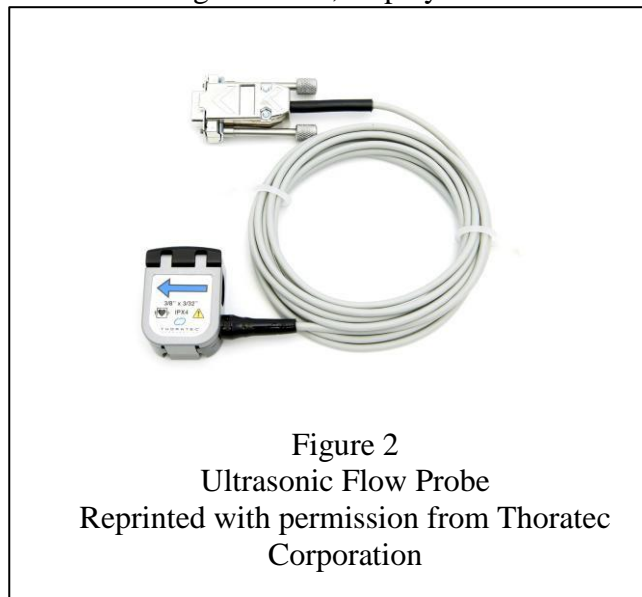

Standard of Care:

Physical Therapy Management of the Patient with a Mechanical Circulatory Support Device

Battery Life

- Primary Console has a 2-3 hour rechargeable battery, alerts when “ON BATTERY” and battery gauge indicates level of battery charge
- Backup Console is not rechargeable

Clot Check

- Performed by nursing every 4 hours by shining a flashlight on the pump, looking for clot (white specs or streaks) especially at the inflow cannula connection to the pump

Normal Ranges

- Pump Speed
 - Goal is for RPMs to maintain adequate blood flow without causing excessive emptying of the ventricle leading to “chugging”
 - If RPMs are increased, flow should also increase
 - Generally 2,500-3,500 RPMs
- Flow
 - Generally 3.0-6.0 LPM, but capable of 10L/min
 - Usually non-pulsatile
 - When it is pulsatile, trend pulse pressure (goal 10-15 mmHg)
- MAP
 - Trended in the ICU via arterial line
 - Goals is for MAP less than 90
- Pump is preload dependent therefore goal is for CVP 10-15

Alarms

- “SYSTEM FAULT” Blood pump will stop, an audible alarm will sound that cannot be muted. Switch to the backup console, motor and flow probe
- “MOTOR STOPPED” Blood pump will stop, audible alarm will sound that can be muted for 60 seconds. Switch to the backup console, motor and flow probe
- “BATTERY MODULE FAIL” The console battery will not function. An audible alarm will sound. Switch to the backup console, motor and flow probe
- “BATTERY BELOW MINIMUM” The blood pump will stop shortly. Plug into AC power. If no AC power available, switch to the backup console, motor and flow probe
- “FLOW PROBE DISCONNECTED” Check the flow probe connection on back of console
- “SYSTEM ALERT” Press the alarm acknowledge button, if the message does not disappear, switch to the backup console, motor and flow probe
- “FLOW BELOW MINIMUM” Low flow. Check for physiologic cause or circuit obstruction.
- “BATTERY MAINTENANCE REQUIRED” Do not use the console
- “LOW BATTERY” Plug the console into AC power. If no AC power is available, switch to the backup console, motor and flow probe
- “ON BATTERY” Verify that the user wants to use battery power, monitor battery charge status

Standard of Care:

Physical Therapy Management of the Patient with a Mechanical Circulatory Support Device

Anticoagulation

- Heparin is started after surgery
- Goal PTT 60-80

“Chugging”

- Inflow cannula to the pump will begin to sway or move violently
- Minimum flow alarm will sound indicating that the pump is likely experiencing inadequate filling
- RN should decrease RPMs in 100 RPM increments until chugging ceases
- Team will assess volume status to determine if the patient is dehydrated, has RV failure, cardiac tamponade, etc.
 - “---” on the L/min screen indicates retrograde flow of >40 mL/min
- If occurs during mobility with PT, the VAD team should be notified

Standard of Care:

Physical Therapy Management of the Patient with a Mechanical Circulatory Support Device



BRIGHAM AND WOMEN'S HOSPITAL
Department of Rehabilitation Services

Physical Therapy

Standard of Care: Mechanical Circulatory Support Device

Appendix D

Cardiac Assist TandemHeart®

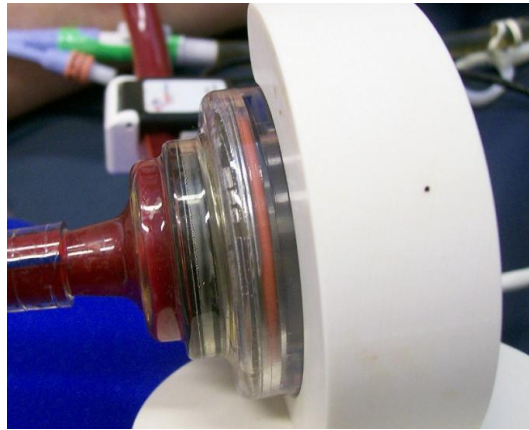

Figure 1
Cardiac Assist TandemHeart®
Photo courtesy of Catherine Saniuk RN, MS, CCRN
Brigham and Women's Hospital

Overview and Indications for Use

- Extracorporeal temporary centrifugal ventricular assist device
- Provides rapid ventricular off-loading and increased systemic perfusion
- Can provide at least 4 liters per minute of flow at 7500 RPMs
- Can be placed percutaneously in the femoral vein and advanced to the right atria in the catheterization lab to provide right ventricular support in patients with a mechanical left ventricular assistive device in place
- Centrally cannulated device can be surgically secured in the operating room to make mobility possible

Contraindications for Use

- Severe peripheral vascular disease

Standard of Care:
Physical Therapy Management of the Patient with a Mechanical Circulatory Support Device

System Components

- Polycarbonate pump with impeller spinning in the “contact-free” chamber
- Motor which applies both levitational and rotational magnetic force (bearing-less)
- System Controller
 - Contains an infusion system and 2 separate controllers (primary and backup)
 - Contains a primary and a backup controller
 - Switchover from the primary to the backup controller occurs automatically and without any alert
 - Controller is kept plugged in at all times, except during transport or mobility

Flow Probe (Figure 2)

- Ultrasonic flow probe placed on the outflow cannula
- Can detect flows from 0.9 to 9.9 L/min
- Clip on design
- Does not need calibrating
- Repositioned once per shift to avoid memory kink on the tubing
- Can detect retrograde flow of >40 mL/min, displayed as “---” instead of L/min on console

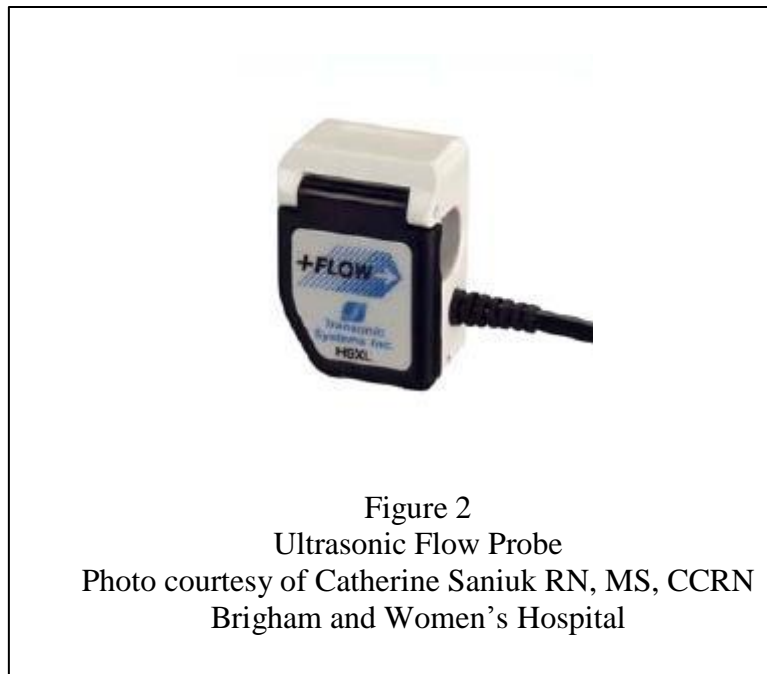

Standard of Care:

Physical Therapy Management of the Patient with a Mechanical Circulatory Support Device

The Pump and Cannula (Figures 3 and 4)

- Inflow cannula transports blood from the patient into the center of the pump
- Outflow cannula transports blood out from the side of the pump to the patient
- Upper Housing Chamber: blood flows into the center of the upper housing chamber via the inflow cannula and is rotated by the impeller at a set speed before being sent back into the patient's circulation via the outflow cannula
- Lower Housing Chamber: includes the motor and the infusate solution, providing cooling and a local anti-coagulation effect

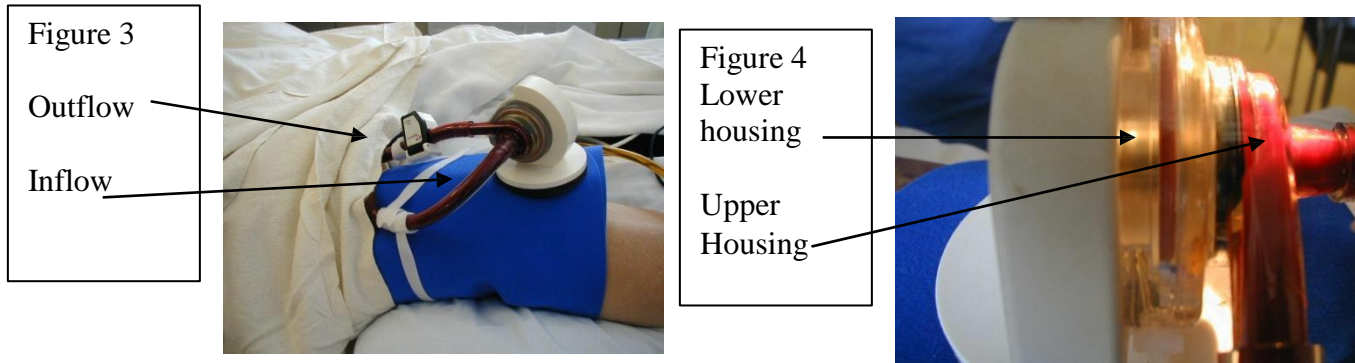

Photos courtesy of Catherine Saniuk RN, MS, CCRN
Brigham and Women's Hospital

Infusate System

- Provides 10 mL/hour IV solution (normal saline, heparin or bivalirudin solution)
- Infused directly into the pump under pressure
- Goal is to cool and lubricate the rotor
- Pressure should be between 100 and 600 mmHg

Battery Life

- System Controller has a 60 minute rechargeable battery, and alerts when "ON BATTERY"
- The battery gauge indicates level of battery charge
- The battery requires 4 hours to recharge

Clot Check

- Performed by nursing every 4 hours, by looking for clot (white specs or streaks) especially at the inflow cannula connection to the pump

Standard of Care:

Physical Therapy Management of the Patient with a Mechanical Circulatory Support Device

Typical Hemodynamics

- Pump Speed
 - Goal is for RPMs to maintain adequate blood flow without causing excessive emptying of the ventricle leading to “chugging”
 - If RPMs are increased, flow should also increase
 - The pump is capable of generating speeds of 3,500-7,500 RPMs
- Flow
 - Detected via the flow probe and is generally a “real” flow
 - Generally 3.0-6.0 L/min

“Chugging”

- Inflow cannula to the pump will begin to sway or move violently
- Minimum flow alarm will alarm, the pump is likely experiencing inadequate filling
- RN should decrease RPMs in 100 rpm increments until chugging ceases
- The VAD team should be notified
- The team will assess volume status, potential causes include
 - Dehydration
 - Right ventricular failure
 - Cardiac tamponade

Anticoagulation

- Heparin begun after surgery
- Goal PTT 60-80

Considerations

- The pumps should be kept visible at all times and should never be covered with bed linen
- The patient should logroll for all bed mobility and care
- Daily dressing changes are conducted by the nursing staff per VAD guidelines
- The pump should be secured with a binder or holster at all times
- The pump should not be touching the skin at any time due to the risk of burns
- Products with acetone (e.g. a permanent marker or nail polish remover) should not ever be used near the site due to the risk of cannula degradation.

Standard of Care:

Physical Therapy Management of the Patient with a Mechanical Circulatory Support Device



Standard of Care: Mechanical Circulatory Support Device

Appendix E

HeartWare® HVAD

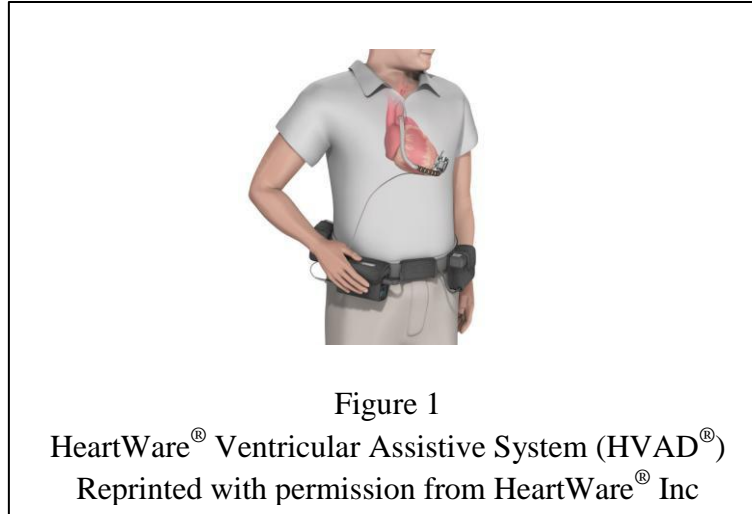

Overview

- Indicated for patients at risk of death with end-stage left ventricular heart failure
- Approved as a bridge to cardiac transplant
- Displaces 50cc blood volume in the left ventricle
- For more detailed information, refer to heartware.com → Clinicians → Instructions for Use

Flow Principles

- Continuous flow
 - Blood travels from the left ventricle, into the HVAD® via the inflow cannula, then exits via the outflow cannula and enters the ascending aorta where blood can be circulated throughout the body before returning to the right ventricle.
- Constant speed
- Can deliver up to 10L/min of flow
- Output is dependent on speed of impeller and pressure differential across the pump
- Works harder during systole than diastole
 - Occurs due to volume of blood in the pump
 - Less chance of suction event or RV dysfunction
- Preload dependent and afterload sensitive
 - Preload is volume of blood returning to the right ventricle, left ventricle or LVAS
 - Afterload is the resistance the RV, LV or LVAD has to pump against to empty
 - Can be affected by volume

Standard of Care:

Physical Therapy Management of the Patient with a Mechanical Circulatory Support Device

Typical Hemodynamics

- Mean arterial pressure (MAP)
 - Must maintain MAP <85 mmHg
 - Can approximate via Doppler blood pressure monitoring
 - Acceptable range for Doppler BP is 65-90 mmHg
- Anticoagulation
 - Long term anticoagulation via Warfarin and Aspirin
 - Target INR 2.0-3.0
- Speed (RPM)
 - Full range is 1800 to 4000 RPM
 - Typical range in patients is 2400 to 3200 RPM
- Power (Watts)
 - Full range is 2.5 to 8.5 Watts
- Flow (L/min)
 - Calculated by a combination of hematocrit and pump speed
 - In the very acute phase, hematocrit must be adjusted daily
 - Full range is -2 to 10 L/min
 - -2 L/min is an invalid but can indicate incorrect hematocrit
 - Flows of 10 L/min and greater can be indicative of a clot or other material in the device or an incorrect hematocrit
 - At flows > 6.5, it is critical to monitor MAP



Figure 2
Monitor Display of HVAD[®] Pump Settings
Reprinted with permission from HeartWare[®] Inc.

Standard of Care:

Physical Therapy Management of the Patient with a Mechanical Circulatory Support Device

- Flow Pulsatility (for graphic representation, refer to “Instructions for Use” on heartware.com)
 - The difference between the maximum (peak) and minimum (trough) of the flow waveform
 - Should be >2 L/min
 - Ideal range is between 2-4 L/min
 - Waveform trough should be >2 L/min

Suction Event (for graphic representation, refer to “Instructions for Use” on heartware.com)

- Occurs during ventricular collapse or inflow occlusion
 - Ventricular collapse occurs if VAD speed is too high and it attempts to pump more blood from the left ventricle than is available, thus reducing the ventricular volume
 - Can be due to hypovolemia due to acute bleeding, right heart failure, arrhythmia, or pulmonary embolus
 - Inflow obstruction is typically temporary and can occur due to surgical positioning, patient positioning, or during a valsalva maneuver

Typical System Components



Figure 3
 HVAD[®] System Components
 1. HVAD[®] Pump 2. Monitor
 3. Controller 4. Batteries 5. Driveline
 Reprinted with permission from HeartWare[®] Inc.

Standard of Care: Physical Therapy Management of the Patient with a Mechanical Circulatory Support Device

The HVAD[®] Pump



Figure 4
HVAD[®] Pump
Reprinted with permission from HeartWare[®] Inc.

- Centrifugal flow pump
- Weighs 160 grams
- Seated inside the pericardium (Figure 4)
- Valveless Pump
- Inflow cannula that is attached directly to the left ventricle (Figure 5)
- Levitating impeller inside housing
 - Barrier between impeller and housing
 - Hydrodynamics make the propeller levitate so there is virtually no friction

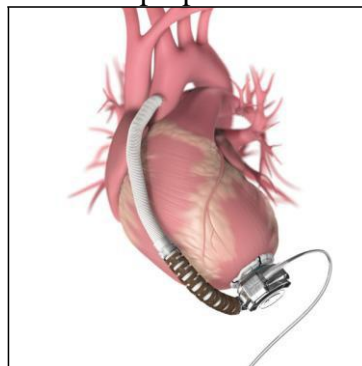

Figure 5
HVAD[®] in-situ with outflow cannula and driveline
Reprinted with permission from HeartWare[®] Inc

Standard of Care:

Physical Therapy Management of the Patient with a Mechanical Circulatory Support Device

- Powered by two separate motors work independently and are connected with pacing wires
 - If one fails, the other can take over
- Outflow cannula travels along the right ventricle and is grafted to the ascending aorta
- Connected to the external controller via a percutaneous driveline
 - Similar to wires used in pacemakers

The Controller (Figure 6)

- Controls and manages VAD operation
- Contains an internal battery to run an audible “No Power” alarm
- Has connections for the driveline, 2 power connection sources and a data connection port that sends signals to the monitor for downloading pump information and adjusting pump settings
- Has an LCD display that shows information on pump operation, battery indicators for both power sources, alarm indicator, alarm mute button, scroll button and AC/DC indicator



Figure 6
 HVAD[®] Controller and LCD Display
 Reprinted with permission from HeartWare[®] Inc.

Standard of Care:
Physical Therapy Management of the Patient with a Mechanical Circulatory Support Device

The Touch Screen Monitor (Figure 7)

- Displays and controls the HeartWare® system and pump
 - Displays pump information
 - Allows for adjustment of pump parameters
 - Monitors and reports system errors and alarms
- Monitor Screen Layout
 - Top of Screen- Alarm messages, status messages, alarm silence and logout buttons
 - Bottom of Screen- Downloading data icon, patient identification, time, postoperative day, controller power supply status, controller power supply source
 - Left Side of Screen- Displays pump information (Speed, Flow, Power)
 - Middle of Screen- Dependent on which of the five information screens is running
- Five icons on the monitor allow for access of different types of information and adjustments
 - Clinical (Home) Screen (Figure 7)
 - Shows real-time power and HVAD® pump flow waveform



Figure 7
HVAD® Monitor Clinical (Home) Screen
Reprinted with permission from HeartWare® Inc

- System Screen
 - Password protected
 - Allows for access to: speed/control adjustments, patient/VAD data, and alarm settings
- Alarm Screen: including alarm log/history and troubleshooting of alarms
- Trend Screen: Flow/Speed and Flow/Power trends
- Monitor Shut Down

Standard of Care:

Physical Therapy Management of the Patient with a Mechanical Circulatory Support Device

Power Sources

- Utilizes AC, DC, or battery power
- Utilizes one power source at a time
 - Completely uses one battery before using the other
- AC adapter (for wall outlet)
 - Green light on adapter will illuminate when plugged into wall outlet and receiving power
 - Must use battery as second power source
 - The HVAD[®] will always use the AC power source as the primary source when plugged in
- DC adapter (for car use)
 - Green light on adapter will illuminate when plugged into car outlet and receiving power
 - Must use battery as second power source
 - The HVAD[®] will always use the AC/DC power source as the primary source when plugged in
 - May not fit in some vehicles
- HeartWare[®] Batteries (See Figure 3 above)
 - Lithium ion cell batteries
 - Weigh ~1 lb each
 - Provide 4-6 hours of power when fully charged
 - Exact amount of time dependent on controller and pump operating power consumption
 - Number of battery charge/discharge cycles
 - Lifetime of battery expected to be >500 cycles
 - Must replace battery when lasting <2 hours of charge
 - Battery power indicator
 - By pushing button on the battery
 - 4 green lights- 75-100%
 - 3 green lights- 50-74%
 - 2 green lights- 25-49%
 - 1 green light- <24% (will switch to other battery automatically)
 - On the controller display
 - 4 green lights- 75-100%
 - 3 green lights- 50-74%
 - 2 yellow lights- 25-49%
 - 1 red light- <25%
 - Only change the battery when the controller instructs to do so

Standard of Care:

Physical Therapy Management of the Patient with a Mechanical Circulatory Support Device

- Battery Charger
 - Can charge up to 4 batteries at a time
 - Takes 5 hours to completely charge a depleted battery
 - Indicator lights show battery charger power, status light and ready light
 - Ready Light
 - Green- Battery is fully charged and ready for use
 - No color- See status light for where battery is in charging status
 - Status Light
 - Yellow- Battery being charged and not ready for use
 - Flashing Yellow- Battery not charging. Check battery connections. If connection is intact, switch to another battery slot. If problem persists contact HeartWare® for a new battery
 - Red- Battery too cold or too hot; waiting to charge
 - Flashing Red- Defective battery. DO NOT use. Return battery to HeartWare®

Changing from AC power to Battery Power

- Locate where the AC power supply connects to the controller (connector has a sleeve that rotates)
- Gently turn the connector sleeve counterclockwise (in the direction of the release arrow) until it stops moving
- Pull straight back to remove the cable it from the controller and place aside
- Locate the battery cable and grasp behind the connector sleeve
- Line up the white arrow on the connector with the white dot at controller insertion site
- Gently push (do not twist) the cable into the controller until it locks (you will hear a click)
- Confirm the cable is locked by gently pulling the cable

Alarms

- High (Critical) Priority Alarms 
 - Blank Display
 - LCD Display Line 1 (Alarm Display)- none
 - LCD Display Line 2 (Action)- none
 - Alarm Tone- continuous loud, unable to mute
 - Alarm Symbol- none
 - Potential Actions- Connect to new power source, replace controller
 - VAD Stopped
 - LCD Display Line 1 (Alarm Display)- ‘VAD Stopped’
 - LCD Display Line 2 (Action)- ‘Connect Driveline’ or ‘Change Controller’
 - Alarm Tone- Loud two-toned, unable to mute
 - Alarm Symbol- Flashing Red Triangle
 - Potential Actions- Reconnect driveline or exchange controller

Standard of Care:

Physical Therapy Management of the Patient with a Mechanical Circulatory Support Device

- Controller Failed, Critical Battery
 - LCD Display Line 1 (Alarm Display)- ‘Controller Failed’ or ‘Critical Battery 1’ or ‘Critical Battery 2’
 - LCD Display Line 2 (Action)- ‘Change Controller’ or ‘Replace Battery 1’ or ‘Replace Battery 2’
 - Alarm Tone- Loud two-toned, unable to mute
 - Alarm Symbol- Flashing Red Triangle
 - Potential Actions- Exchange controller, Replace critical battery with fully charged battery or AC/DC adapter, change controller if new power sources do not correct alarm

- Medium Priority Alarms 
 - Alarm Tone- Intermittent beep (gradual increase in alarm volume over time if not muted), able to mute alarm for 5 minutes or 1 hour, electrical fault and controller fault audio alarms can be permanently disabled, press the scroll button on the controller to clear resolved medium alarm messages
 - Alarm Symbol- Flashing Yellow Triangle
 - Controller Fault
 - LCD Display Line 1 (Alarm Display)- ‘Controller Fault’
 - LCD Display Line 2 (Action)- ‘Call’ or ‘Call: ALARMS OFF’
 - Potential Causes- Controller component malfunction but pump still working
 - High Watt
 - LCD Display Line 1 (Alarm Display)- ‘High Watt’
 - LCD Display Line 2 (Action)- ‘Call’
 - Potential Causes- Power (watts) have exceeded high power threshold, high RPM, high flow, LVAD electrical fault
 - Electrical Fault
 - LCD Display Line 1 (Alarm Display)- ‘Electrical Fault’
 - LCD Display Line 2 (Action)- ‘Call’
 - Potential Causes- fault in pump-to-controller electrical connections, partial driveline fracture, connector malfunction, controller component failure, VAD failure, controller dropped
 - Low Flow
 - LCD Display Line 1 (Alarm Display)- ‘Low Flow’
 - LCD Display Line 2 (Action)- ‘Call’
 - Potential Causes- average flow below low flow alarm threshold, suction, RPM too high or too low, poor VAD filling, high blood pressure, outflow graft kink
 - Suction
 - LCD Display Line 1 (Alarm Display)- ‘Suction’
 - LCD Display Line 2 (Action)- ‘Call’
 - Potential Causes- RPM too high, poor VAD filling, thrombus

Standard of Care:

Physical Therapy Management of the Patient with a Mechanical Circulatory Support Device

- Low Priority Alarms 
 - Alarm Tone- Intermittent beep (gradual increase in alarm volume over time if not muted), able to mute alarm for 5 minutes
 - Alarm Symbol- Solid Yellow Triangle
 - Low Battery, Power Disconnect
 - LCD Display Line 1 (Alarm Display) - ‘Low Battery 1’, ‘Low Battery 2’ or ‘Power Disconnect’
 - LCD Display Line 2 (Action) - ‘Replace Battery 1’, ‘Replace Battery 2’, ‘Reconnect Power 1’, or ‘Reconnect Power 2’
 - Potential Causes - Battery power is low, power source is disconnected or malfunctioning

Special Equipment

- Patients will be fit with an abdominal binder
 - In some cases, this will be custom made by an Occupational Therapist
- Patients will receive a patient pack, waist belt or shoulder bag with pockets for the controller and batteries
- Patients will receive a shower bag that is water resistant
 - Occupational Therapist will review showering procedures
- Patients will receive a travel bag for backup equipment

Emergency Procedures

- Changing the controller
 - Have patient sit or lie down
 - Place new controller in reach
 - Connect new controller to power supply
 - A power disconnect alarm will activate if a second source is not connected to the new controller within 20 seconds of controller power up
 - A VAD stopped alarm will activate if the pump driveline is not connected to the new controller within 10 seconds (will resolve once driveline is connected)
 - Pull the white cover from the primary controller to reveal the silver connector of the driveline
 - Disconnect the driveline from the primary controller by pulling the silver connector away from the controller
 - Connect the driveline to the new controller by aligning the red dot on the driveline connector with the red dot on the controller and pushing together
 - An audible click will indicate a secure connection
 - Remove the red alarm adapter from the primary controller and remove the power supply
 - Slide the white cover over the driveline connection site on the new driver

Standard of Care:

Physical Therapy Management of the Patient with a Mechanical Circulatory Support Device

Special PT Considerations

- Travelling out of the patient's room
 - Must bring travel bag
 - Contains backup controller, two fully-charged spare batteries, AC/DC power cord
- Hemodynamic monitoring
 - Blood pressure- via Doppler
 - Flow pulsatility- when monitor is in use during the immediate post-operative phase
 - When patient's become more stable, monitor will not be readily available during PT session
 - Must closely monitor patient's symptoms and blood pressure to ensure hemodynamic and pump stability

Standard of Care:

Physical Therapy Management of the Patient with a Mechanical Circulatory Support Device



BRIGHAM AND WOMEN'S HOSPITAL

Department of Rehabilitation Services

Physical Therapy

Standard of Care: Mechanical Circulatory Support Device

Appendix F

SynCardia temporary Total Artificial Heart (TAH-t)

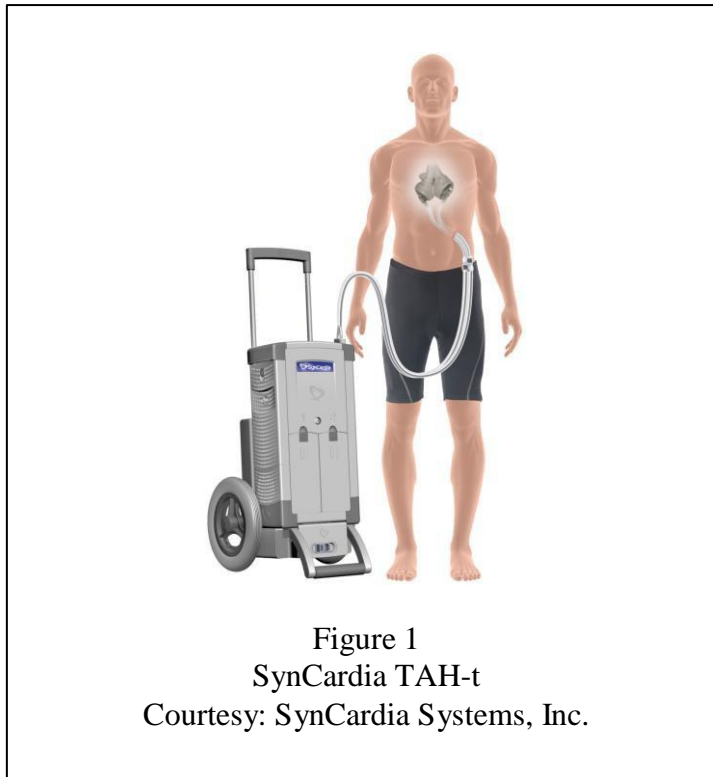

Figure 1
SynCardia TAH-t
Courtesy: SynCardia Systems, Inc.

Overview

- Pulsatile, biventricular pneumatic driven orthotopic device
- Replaces both native heart ventricles and heart valves in patients with biventricular heart failure at risk for imminent death
- Weighs 160 grams (~1/3 of a pound)
- Occupies 400 cm² of space
- Two Sizes
 - 70cc TAH-t currently approved in US and Canada as a bridge to transplant in eligible patients with BSA of 1.7m³ or greater. This device has been used in patients with BSA >1.5m³
 - 50cc TAH-t currently under development and in clinical trials (awaiting FDA approval) for patients as a bridge to transplant in both adult and pediatric patients or a destination therapy in adults with BSA between 1.2m³ and 1.79m³

Standard of Care:

Physical Therapy Management of the Patient with a Mechanical Circulatory Support Device

The Device

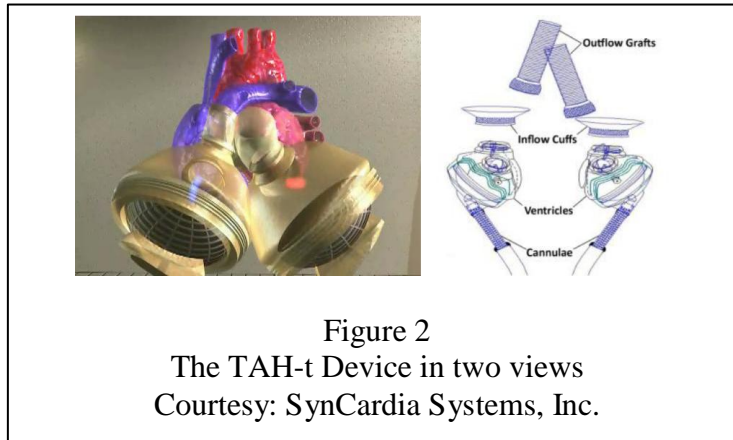

- Artificial ventricles each have a fill volume of 70mL and consist of inner diaphragms surrounded by a rigid outer polycarbonate casing
- Inner polyurethane diaphragms separate blood from air pressure pulses
- Has unidirectional inflow and outflow tilting valves
- Air pressure pulses controlled by external driver
- Large inflow conduit allows for high cardiac output of up to 9.5 L/min

The Pump Cycle (Figure 3)

- Blood exits the native right atrium and enters the artificial right ventricle which partially fills before fully ejecting through a short outflow cannula grafted to the pulmonary artery to enter the lungs
- Blood returns from the lungs into the left atrium, flows into the artificial left ventricle which partially fills before fully ejecting through an outflow cannula grafted to the aorta to circulate the body with oxygenated blood.

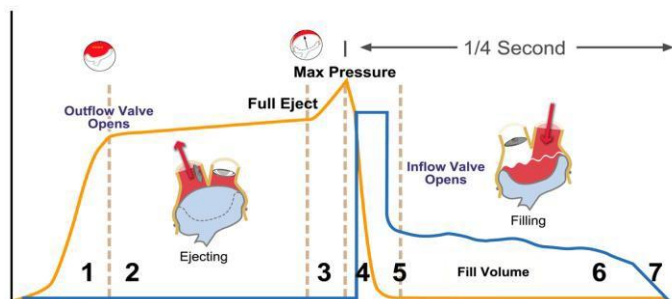

Figure 3
Graphical representation of cardiac cycle in the TAH-t
Courtesy: SynCardia Systems, Inc.

Standard of Care:

Physical Therapy Management of the Patient with a Mechanical Circulatory Support Device

Typical Hemodynamics

- Native heart rate should be 125 ± 15 bpm; device settings allow range of 40 to 150 bpm
- Drive pressures
 - Left: 180 to 210mmHg needed to overcome native pressure but device settings allow range of 120 to 280 mmHg
 - Right: 60-100mmHg but device settings allow range of 40 to 150 mmHg
- Percent systole should be $50\% \pm 5\%$ at rest, 60% or less with activity but device settings allow range of 40 to 60%
- Vacuum control
 - Right: 0 to -10 mmHg but device settings allow range of 0 to -30 mmHg
 - Left: 0 to -13 mmHg but device settings allow range of 0 to -30 mmHg. Left vacuum typically lower than right.

Companion 2 Driver

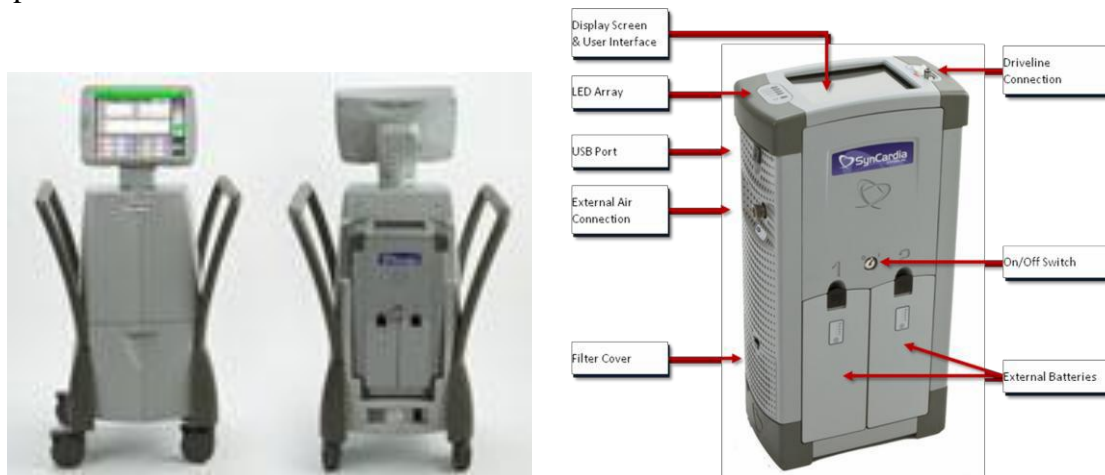

Figure 4
Companion 2 Driver shown docked in the hospital cart and by itself
Courtesy: SynCardia Systems, Inc.

Overview

- Pneumatic driver delivers pulses through drive lines to push air into the air chambers of the ventricles to distend the diaphragms in order to eject the blood from the TAH-t
- Three modes
 - OR mode- Requires password, muted alarms, full menu access, System Check
 - ICU mode- Requires password to enter ICU mode from ambulatory mode, double confirmation required for parameter changes
 - Ambulatory mode- No parameter changes permitted, ability to minimize graph and settings data

Standard of Care:

Physical Therapy Management of the Patient with a Mechanical Circulatory Support Device

- Driver can be docked in the hospital cart or caddy
 - Hospital cart is larger, more difficult to move
 - Allows for more parameter changes
 - Caddy allows for easier patient mobility
 - Screen displays: Device rate, Stroke volume, Cardiac output, Drive pressure, Flow waveforms, Cardiac output trends, Alarms



Display Screen and User Interface



Figure 6
TAH-t User Interface Screen
Courtesy: SynCardia Systems, Inc.

Standard of Care: Physical Therapy Management of the Patient with a Mechanical Circulatory Support Device

- Touchscreen display can be used to monitor and change settings (depending on mode)
- Alarms at top of screen via ‘Alarm Bar’
- Graphical display of TAH-t function (pressure waveform, flow waveform, cardiac output waveform)
- Real-time numerical values output data (Left/Right cardiac output, Left/Right average cardiac output, Left/Right fill)
- Driver settings (Rate, Percent systole, Left drive pressure, Right drive pressure, Left/Right vacuum, Average cardiac output)
- Displays Air source (external vs. internal)
- Power Management displays what power source is being used and how much battery is remaining along with when the Emergency battery is in use

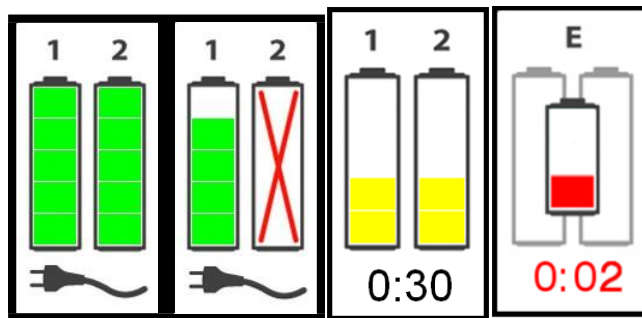

Figure 7
Battery Power Indicators as shown on display monitor
Courtesy: SynCardia Systems, Inc.

Waveforms

- Flow Waveform
 - Want to see graph indicative of partial filling of the ventricle demonstrated by graph line staying above baseline level
- Pressure Waveform
 - Want to see graph indicative of full ejection from ventricle via “Full Eject Flag”

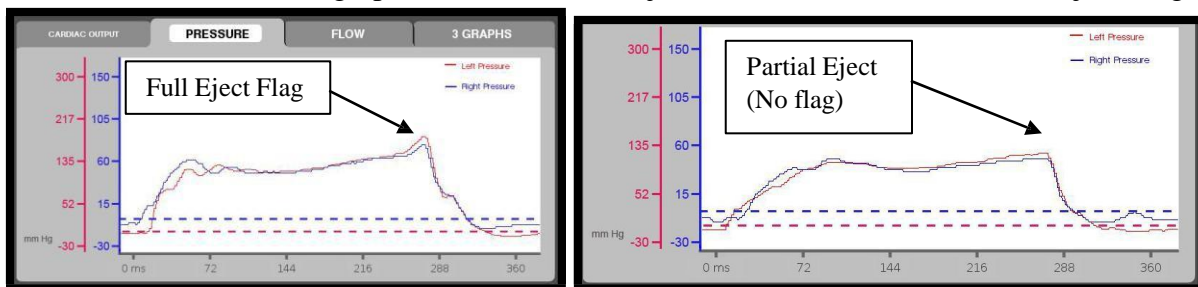

Figure 8
Graphical representation of full vs. partial ejection
Courtesy: SynCardia Systems, Inc.

Standard of Care:

Physical Therapy Management of the Patient with a Mechanical Circulatory Support Device

Air Source

- Utilizes compressed air from internal or external source
- External air obtained via yellow air connector to the driver from the hospital wall, ideally with air pressure between 40-60 PSI
- Internal air obtained via internal compressor (no external compressed air tanks) within the driver

Alarms

- High Priority Alarms
 - Very Low Left Cardiac Output- Flashing Red Alarm Bar, Flashing red Alarm Indicator LED, 10 beeps every 2 ½ seconds
 - Emergency Battery in Use- Flashing red alarm bar, Flashing red Emergency Battery Indicator, 10 beeps every 2 ½ seconds
 - Low Left Cardiac Output- Red Alarm Bar, Red Alarm Indicator LED, 10 beeps every 5 seconds
 - Low Right Pressure- Red Alarm Bar, Red Alarm Indicator LED, 10 beeps every 5 seconds
- Low Priority Alarms
 - Very Low External Battery- Flashing Yellow Alarm Bar, Flashing Yellow Alarm Indicator LED, Flashing Yellow Battery ½ Indicator, 3 beeps every 30 seconds
 - Left Fill Volume High- Left Fill Volume Box background is yellow, Flashing Yellow Alarm Bar, Flashing Yellow Alarm Indicator LED, 3 beeps every 30 seconds
 - Low External Battery- Yellow Alarm Bar, Yellow Alarm Indicator LED, Yellow Battery Indicator, 2 beeps every 3 ½ seconds
 - Right Vacuum Incorrect- Yellow Alarm Bar, Yellow Alarm Indicator LED, 2 beeps every 3 ½ seconds
- Can View Alarm History via touchscreen interface

Special Considerations for PT

- With activity, systolic blood pressure may decrease.
- Parameters to know:
 - Cardiac output: Decrease activity when CO > 8.0 L/min
 - Fill Volume: Decrease activity when FV > 65 mL or high fill alarm sounds
 - Blood Pressure: No initiation of therapy if SBP ≥ 130 mmHg, termination of therapy if SBP ≥ 140 mmHg

Standard of Care:

Physical Therapy Management of the Patient with a Mechanical Circulatory Support Device

Emergency Procedures

- In an emergency situation where the current driver malfunctions, it is required to switch to a backup driver
 - Switching to another Companion 2 Driver
 - Turn on backup driver (takes approximately 10 seconds to begin pumping)
 - Move driveline from primary driver to backup driver
 - Depress tab on side of connector to disconnect
 - Verify adequate battery charge and/or AC power supply connection on new driver
 - Switching to Freedom[®] Driver
 - Will need two people, wire cutter and wire ties
 - Turn on Freedom[®] Driver, Remove Freedom[®] driveline caps, insert two batteries and connect to AC power
 - Cut wire ties on Companion driveline
 - Simultaneously disconnect red and blue cannula from Companion drivelines
 - Connect to red and blue Freedom[®] drivelines
 - Secure connector release buttons with wire ties

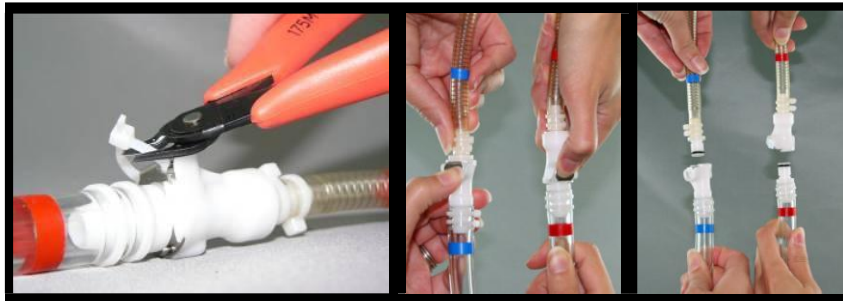

Figure 10
Disconnecting and reconnecting drive line from Companion 2
Driver to Freedom[®]
Driver
Courtesy: SynCardia Systems, Inc.

Standard of Care:

Physical Therapy Management of the Patient with a Mechanical Circulatory Support Device

- Hand Pumping



Figure 11
SynCardia hand pump used in emergency procedure
Courtesy: SynCardia Systems, Inc.

- Used in emergency situations only when a backup driver is not immediately available
- Disconnect Driveline from driver
- Connect Driveline to hand pump
- Pump at rate of 110 strokes per minute to provide adequate cardiac output until a backup driver is available

Standard of Care:

Physical Therapy Management of the Patient with a Mechanical Circulatory Support Device

Freedom Portable Driver



Figure 12
SynCardia Freedom[®] Driver connected to the TAH-t
Courtesy: SynCardia Systems, Inc.

Overview

- Lightweight and portable (13.5 pounds) and fits in backpack or shoulder bag
- 6 feet of line from patient to the driver
- Patients must be clinically stable (off all IV medications)
 - Systolic blood pressure must remain below 140 mmHg
- Only adjustable setting is the beat rate
- Has air compressor
- Can be connected to external AC power source or use battery power
 - Batteries insert directly into driver
 - Batteries contain approximately 2 hours of power

Standard of Care:

Physical Therapy Management of the Patient with a Mechanical Circulatory Support Device

- Has small LCD display (Figure 13)
 - Shows single beat rate (BPM), Fill Volume (FV), Cardiac Output (CO), Alarm indicators that are indicative of LV function



Figure 13

Freedom portable driver with illuminated display and battery indicators
 Courtesy: SynCardia Systems, Inc.

Power Source

- External- AC or DC power sources from wall or car, respectively
 - Cords plug directly into power adapter attached to the Freedom[®] Driver
- Battery power
 - Utilizes two batteries at a time
 - Provide approximately 2 hours of support according to Driver settings
 - Five green lights indicate amount of charge
 - Each light illuminated represents approximately 20% charge
 - Only one battery can be removed at a time
 - Driver must be plugged into an external power source
 - Push down on the battery release button at the front of the driver
 - When replacing a new battery, must ensure that the battery locks into place
- Charging batteries



Figure 14

Batteries charging in dock connected to AC power
 Courtesy: SynCardia Systems, Inc.

- Battery charging dock holds up to four batteries at a time
- Charger plugs into an AC power source
- To make sure batteries are charging, depress the battery charge button at the top of the battery
 - A blinking light on the battery fuel gauge indicates battery is charging when battery charge button is depressed
 - Batteries are done charging when 5 green lights illuminate without blinking when battery charge button is depressed

Alarms

- Three Types: Battery Alarm, Temperature Alarm, Fault Alarm
 - All will have a visual and audio alarm
- Battery Alarm
 - Loud Intermittent Tone, Yellow Battery LED flashing
 - Indicative of one or both of the batteries having less than 35% charge remaining, onboard battery is incorrectly installed, one onboard battery is missing
- Temperature Alarm
 - Loud Intermittent Tone, Red Alarm LED flashing
 - Indicative of internal temperature of driver too hot, onboard batteries is too hot
- Fault Alarm
 - Loud Continuous Tone, Red Alarm LED solid
 - Indicative of kinked or disconnected driveling, driver malfunction, low cardiac output (can be caused by valsalva or elevated SBP)

Emergency Procedures

- In an emergency situation where the current driver malfunctions, it is required to switch to a backup driver
 - Switching to backup Freedom[®] Driver
 - Requires two people, wire cutters and wire ties
 - Power on the backup driver
 - Remove the driveline caps, insert one charged battery, remove dummy battery and insert second battery, connect the driver to a wall power outlet
 - Cut wire ties on Companion driveline
 - Simultaneously disconnect red and blue cannula from Companion drivelines
 - Connect to red and blue Freedom[®] drivelines
 - Secure connector release buttons with wire ties

Physical Therapy Considerations

- When travelling outside of the patient's room
 - Must bring travel bag with backup Freedom[®] driver with dummy batter and fully charged battery inserted, 2 fully charged additional batteries, AC power adapter

Big Blue

- Air Source
 - Runs on external air
 - Will automatically change from air on wall unit to primary tank and then reserve tank based on highest air pressure system
 - For ambulation outside of the room, there is a caddy that holds 4 tanks
 - For longer excursions, take an extra air tank
 - Must always disconnect adapter from wall air unit instead of from Big Blue when changing oxygen source for travel
 - Primary air tank
 - Has approximately one hour of air
 - Located on left side of Big Blue
 - Runs on 4000 PSI
 - Will alarm when at 1000 PSI
 - Automatically activates when Big Blue is disconnected from wall air unit
 - Must always reconnect to wall air unit when returning from excursion
 - Reserve Air Tank
 - Has approximately one hour of air
 - Do not want to use unless absolutely necessary
 - Located on right side of Big Blue
 - Will alarm at 3000 PSI
 - Alarm will go off every 3 minutes 30 second until replaced with a full tank to reset the alarm
- 3 Panels
 - Primary Driver, Secondary Driver, Air System Panel
 - Air system Panel
 - Utilizes a graduated alarm system with the most common alarms being the orange and yellow alarms. Red alarms are most serious
 - Primary Driver (and secondary driver if in use)
 - Red and Blue waveforms
 - Red line shows right ventricle function
 - Blue line shows left ventricle function
 - Filling is indicative of diastole
 - Only want partial filling
 - Measure of blood flow is equal to air flow
 - If HR decreases, the time blood is in the ventricle increases
 - Vacuum
 - Pulls air to decrease resistance in the system
 - Vacuum increase to ≤ 40 can create atrial suction

Works Cited

1. World Health Organization. International statistical classification of diseases and related health problems 10th revision. <http://www.who.int/classifications/apps/icd/icd10online/>. Published 05/04/2006. Updated 2010. Accessed 10/2014, 2014.
2. Lloyd-Jones D, Adams R, Carnethon M, et al. Heart disease and stroke statistics--2009 update: A report from the american heart association statistics committee and stroke statistics subcommittee. *Circulation*. 2009;119(3):e21.
3. Braunwald E. Heart failure. *JACC Heart Fail*. 2013;1(1):1-20.
4. Shapiro PA, Levin HR, Oz MC. Left ventricular assist devices psychosocial burden and implications for heart transplant programs. *Gen Hosp Psychiatry*. 1996;18:30-35.
5. Shoemaker M, J., Caskell A, VandeBunte K, et al. Early ambulation predicts length of stay and discharge location following left ventricular assist device implantation. *Cardiopulm Phys Ther J*. 2014;25(3):75-84.
6. Boehmer JP, Popjes E. Cardiac failure: Mechanical support strategies. *Crit Care Med*. 2006;34(9):S268.
7. Slepian M. The SynCardia temporary total artificial heart-- evolving clinical role and future status. *US Cardiol*. 2011;8(1):39-46.
8. Shah KB, Tang DG, Cooke RH, et al. Implantable mechanical circulatory support: Demystifying patients with ventricular assist devices and artificial hearts. *Clin Cardiol*. 2011;34(3):147-152.

9. Platis A, Larson DF. CardioWest temporary total artificial heart. *Perfusion*. 2009;24(5):341-346.
10. Boldt C, Grill E, Wildner M. ICF core set for patients with cardiopulmonary conditions in the acute hospital. *Disabil Rehabil*. 2005;27(7-8):375-380.
11. Boyle AJ, Jorde UP, Sun B, et al. Pre-operative risk factors of bleeding and stroke during left ventricular assist device support: An analysis of more than 900 HeartMate II outpatients. *J Am Coll Cardiol*. 2014;63(9):880-888.
12. Shah MR, Naftel DC, Miller MA, et al. Thrombotic complications increase after percutaneous Site/Pocket infection in patients with left ventricular assist devices: An INTERMACS analysis. *J Heart Lung Transplant*. 2013;32(4):84-85.
13. Monkowski D, Axelrod P, Fekete T, Hollander T, Furukawa S, Samuel R. Infections associated with ventricular assist devices: Epidemiology and effect on prognosis after transplantation. *Transpl Infect Dis*. 2007;9(2):114.
14. Mancini D, Goldsmith R, Levin H, et al. Comparison of exercise performance in patients with chronic severe heart failure versus left ventricular assist devices. *Circulation*. 1998;98(12):1178-1183.
15. Oz MC, Argenziano M, Catanese KA, et al. Bridge experience with long-term implantable left ventricular assist devices are they an alternative to transplantation? *Circulation*. 1997;95(7):1844-1852.

16. Potapov EV, Loforte A, Weng Y, et al. Experience with over 1000 implanted ventricular assist devices. *J Card Surg.* 2008;23(3):185-194.
17. Mountis MM, Starling RC. Management of left ventricular assist devices after surgery: Bridge, destination, and recovery. *Curr Opin Cardiol.* 2009;24(3):252.
18. Kohli HS, Canada J, Arena R, et al. Exercise blood pressure response during assisted circulatory support: Comparison of the total artificial heart with a left ventricular assist device during rehabilitation. *J Heart Lung Transplant.* 2011;30(11):1207-1213.
19. Nicholson C, Paz JC. Total artificial heart and physical therapy management. *Cardiopulm Phys Ther J.* 2010;21(2):13-21.
20. Holman WL, Rayburn BK, McGiffin DC, et al. Infection in ventricular assist devices: Prevention and treatment. *Ann Thorac Surg.* 2003;75(90060):48-57.
21. Bijur PE, Silver W, Gallagher EJ. Reliability of the visual analog scale for measurement of acute pain. *Acad Emerg Med.* 2001;8(12):1153-1157.
22. Scheiderer R, Belden C, Schwab D, Haney C, Paz J. Exercise guidelines for inpatients following ventricular assist device placement: A systematic review of the literature. *Cardiopulm Phys Ther J.* 2013;24(2):35-42.
23. Freeman R ., Maley K . Mobilization of intensive care cardiac surgery patients on mechanical circulatory support. *Crit Care Nurs Q.* 2013;36(1):73-88.

24. Kennedy MD, Haykowsky M, Humphrey R. Function, eligibility, outcomes, and exercise capacity associated with left ventricular assist devices: Exercise rehabilitation and training for patients with ventricular assist devices. *J Cardiopulm Rehabil.* 2003;23(3):208-217.
25. Catanese KA, Goldstein DJ, Williams DL, et al. Outpatient left ventricular assist device support: A destination rather than a bridge. *Ann Thorac Surg.* 1996;62(3):646-652.
26. ATS Committee on Proficiency Standards for Clinical Pulmonary Function, Laboratories. ATS statement: Guidelines for the six-minute walk test. *Am J Respir Crit Care Med.* 2002;166(1):111-117.
27. Enright PL, Sherrill DL. Reference equations for the six-minute walk in healthy adults. *Am J Respir Crit Care Med.* 1998;158(5):1384-1387.
28. Gibbons W, Fruchter N, Sloan S, Levy R. Reference values for a multiple repetition 6-minute walk test in healthy adults older than 20 years. *J Cardiopulm Rehabil.* 2001;21(2):87-93.
29. Humphrey R, Buck L, Cahalin L, Morrone T. Physical therapy assessment and intervention for patients with left ventricular assist devices. *Cardiopulm Phys Ther J.* 1998;9:3-7.
30. Petrucci RJ, Truesdell KC, Carter A, et al. Cognitive dysfunction in advanced heart failure and prospective cardiac assist device patients. *Ann Thorac Surg.* 2006;81(5):1738-1744.
31. Branch KR, Dembitsky WP, Peterson KL, et al. Physiology of the native heart and thermo cardiosystems left ventricular assist device complex at rest and during exercise: Implications for chronic support. *J Heart Lung Transplant.* 1994;13(4):641-50; discussion 651.

32. Foray A, Williams D, Reemtsma K, Oz M, Mancini D. Assessment of submaximal exercise capacity in patients with left ventricular assist devices. *Circulation*. 1996;94(9 Suppl):II222-6.
33. Shepherd J, Wilding C. Occupational therapy for people with ventricular assist devices. *Aust Occup Ther J*. 2006;53(1):47.
34. Grady KL, Meyer P, Mattea A, et al. Improvement in quality of life outcomes 2 weeks after left ventricular assist device implantation. *J Heart Lung Transplant*. 2001;20(6):657-669.
35. Grady KL, Meyer P, Mattea A, et al. Predictors of quality of life at 1 month after implantation of a left ventricular assist device. *Am J Crit Care*. 2002;11(4):345-352.